



# INFORM SERIES

01.01.2024



# THE INFORM SERIES

Greet the users of the library with the clear design of the Inform series of counters, desks and search stations.

The Inform series is easily recognized due to its up to 40 mm thick panels, creating a continuous frame around the work space. The counter system is specially designed for library use and is both functional, expandable and allows to a great extent customization to your needs. Compliment the counter with desks and search stations placed strategically around the library to create functional and user friendly work spaces for both the staff as well as the users of the library.

All three types of work spaces have a range of accessories available to create the right setting for all users.



<b>DESIGN OPTIONS</b> .....	4	<b>COUNTER SHELVES</b> .....	84
<b>TECHNICAL SPECIFICATIONS</b> .....	9	For rectangular counter .....	88
<b>SEARCH STATION</b> .....	10	For corner counter .....	89
<b>DESKS</b> .....	12	For 45° curved counter .....	90
<b>COUNTER</b> .....	18	For 90° curved counter .....	91
<b>CONFIGURATION OPTIONS</b> .....	19	<b>DISPLAY AND STORAGE</b> .....	92
<b>STANDARD COUNTER</b> .....	20	Corner display unit .....	93
Rectangular counter .....	22	Display cabinet with storage .....	95
45° curved counter .....	24	Display cabinet with drawers .....	97
90° curved counter .....	26	Display cabinet with shelves and shelving options .....	98
Rectangular counter (combination with recessed counter) .....	28	Display cabinet with book trolley .....	99
45° curved counter (combination with recessed counter) .....	30	Accessories for display cabinet .....	100
90° curved counter (combination with recessed counter) .....	32	<b>FUNCTIONS</b> .....	101
Connections .....	34	Bag shelves .....	103
Configurations .....	35	Counter top part with info sign .....	106
<b>RECESSED COUNTER</b> .....	36	Counter top part with bag shelf .....	108
Rectangular counter .....	38	Decorative board and info sign .....	111
45° curved counter .....	40	Functional accessories .....	113
90° curved counter .....	42	Power sockets .....	115
Rectangular counter (combination with standard counter) .....	44	<b>FRONT PANEL OPTIONS</b> .....	116
45° curved counter (combination with standard counter) .....	46	LED lighting .....	117
90° curved counter (combination with standard counter) .....	46	Graphics .....	119
Connections .....	50	<b>DRILL HOLES FOR CABLE CONDUCT &amp; RFID</b> .....	120
Configurations .....	51		
<b>STEP COUNTER</b> .....	52		
Counter tops .....	54		
Front panels .....	55		
Middle panels .....	56		
Configurations .....	57		
<b>CORNER COUNTER</b> .....	58		
Square corner counter top and front panel .....	60		
Triangular corner counter top and front panel .....	61		
<b>INFO TABLES</b> .....	62		
Counter top with foot and side panel .....	64		
Counter top with panel and side panel .....	65		
<b>HEIGHT ADJUSTABLE COUNTER</b> .....	66		
Height adjustable rectangular counter .....	70		
H740 mm rectangular counter for height adjustable .....	72		
H740 mm 45° curved counter for height adjustable .....	74		
H740 mm 90° curved counter for height adjustable .....	76		
H740 mm 45° curved counter for height adjustable and recessed .....	78		
H740 mm 90° curved counter for height adjustable and recessed .....	79		
Square corner counter for height adjustable .....	80		
Triangular corner counter for height adjustable .....	81		
Middle panels .....	82		
Configurations .....	83		

# DESIGN OPTIONS

## STEEL COMPONENTS - PAINTED

### A PRICE GROUP - BASIS PRICE (smooth finish)



**A03**  
**Traffic white**  
RAL 9016  
Gloss 75-90



**A02**  
**Oyster white**  
RAL 1013  
Gloss 40-50

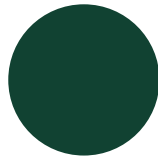

**A22**  
**Moss green**  
RAL 6005  
Gloss 71-85

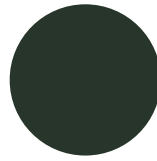

**A26**  
**Fir green**  
RAL 6009  
Gloss 71-85

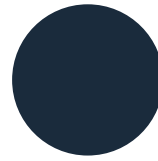

**A12**  
**Steel blue**  
RAL 5011  
Gloss 71-85

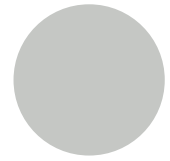

**A13**  
**Light grey**  
RAL 7035  
Gloss 71-85

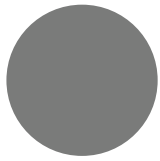

**A15**  
**Dusty grey**  
RAL 7037  
Gloss 71-85

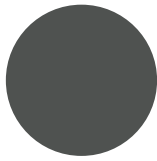

**A16**  
**Traffic grey**  
RAL 7043  
Gloss 71-85

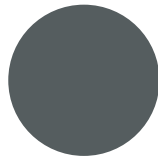

**A17**  
**Basalt grey**  
RAL 7012  
Gloss 71-85

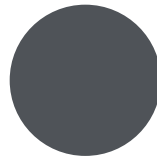

**A18**  
**Slate grey**  
RAL 7015  
Gloss 71-85

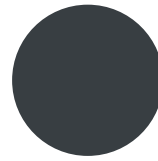

**A19**  
**Anthracite grey**  
RAL 7016  
Gloss 71-85

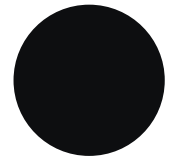

**A25**  
**Jet black**  
RAL 9005  
Gloss 71-85

### B PRICE GROUP - BASIS PRICE WITH 7% SURCHARGE (smooth finish)



**A01**  
**Pure white**  
RAL 9010  
Gloss 71-85

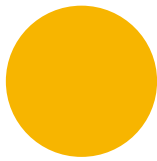

**A04**  
**Traffic yellow**  
RAL 1023  
Gloss 71-85

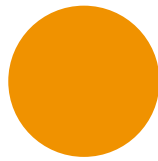

**A05**  
**Sun yellow**  
RAL 1037  
Gloss 71-85

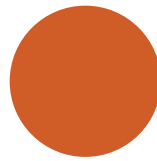

**A06**  
**Signal orange**  
RAL 2010  
Gloss 71-85

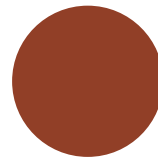

**A07**  
**Pearl orange**  
RAL 2013  
Gloss 65-85



**A08**  
**Flame red**  
RAL 3000  
Gloss 71-85

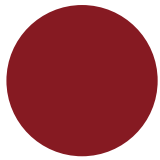

**A09**  
**Ruby red**  
RAL 3003  
Gloss 71-85



**A21**  
**Reseda green**  
RAL 6011  
Gloss 71-85

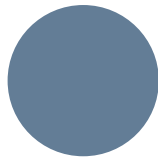

**A10**  
**Pigeon blue**  
RAL 5014  
Gloss 71-85

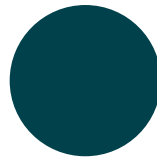

**A11**  
**Ocean blue**  
RAL 5020  
Gloss 71-85

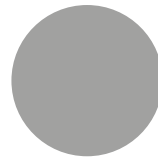

**A14**  
**White aluminium**  
RAL 9006  
Gloss 50-70

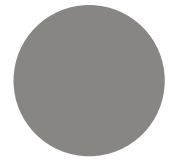

**A31**  
**Grey aluminium**  
RAL 9007  
Gloss 50-70

### B PRICE GROUP - BASIS PRICE WITH 7% SURCHARGE (textured finish)



**A27**  
**Pure white**  
RAL 9010

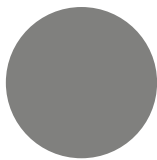

**A29**  
**Concertina grey**

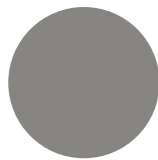

**A28**  
**Grey aluminium**  
RAL 9007

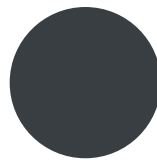

**A23**  
**Anthracite grey**  
RAL 7016

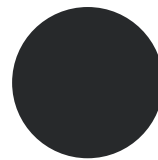

**A24**  
**Graphite black**  
RAL 9011

#### Note:

- Other RAL/NCS colours have a starter fee of GBP 215 / EUR 250 and a surcharge of 15%. A higher surcharge for colours with "metallic" look or different surface textures must be expected.
- See specific colour for steel gloss specification. Special requests outside specified gloss range are not covered by the above surcharges.

# DESIGN OPTIONS

## ACRYLIC COMPONENTS

### **A** PRICE GROUP - BASIS PRICE

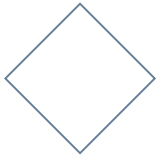

**030**  
Crystal clear



**046**  
Frost white



**047**  
Arctic blue



**048**  
Paprika red

#### **Note:**

- The acrylic front panels can be combined with acrylic side panels on shelving in the same colour. They can also be combined with lighting.

# DESIGN OPTIONS

WOODEN COMPONENTS - MELAMINE/LAMINATE

## A PRICE GROUP - BASIS PRICE

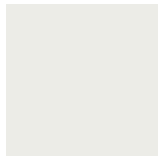

**D61/L61**  
**Signal white**  
RAL 9003



**D72/L72**  
**Oyster white**  
Similar to RAL 1013

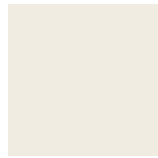

**D62/L62**  
**Pure white**  
Similar to RAL 9010



**D63/L63**  
**Steel blue**  
RAL 5011



**D71/L71**  
**Dusty grey**  
Similar to RAL 7037



**D16/L16**  
**Basalt grey**  
Similar to RAL 7012



**D19/L19**  
**Slate grey**  
Similar to RAL 7015 and RAL 7016



**D04/L04**  
**Beech decor**



**D05/L05**  
**Maple decor**

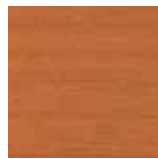

**D06/L06**  
**Cherry decor**



**D07/L07**  
**Oak decor**



**D08/L08**  
**Olive decor**

## C PRICE GROUP - BASIS PRICE WITH 10% SURCHARGE



**D64/L64**  
**Signal yellow**  
RAL 1003



**D65/L65**  
**Yellow orange**  
RAL 2000



**D66/L66**  
**Pure orange**  
RAL 2004



**D67/L67**  
**Traffic red**  
RAL 3020



**E02/L02**  
**Ruby red**  
Similar to RAL 3003



**D13/L13**  
**Lime green**  
Similar to NCS S1060-G40Y



**D68/L68**  
**Reseda green**  
Similar to RAL 6011



**D14/L14**  
**Crystal blue**  
Similar to NCS S1020-R90B



**D73/L73**  
**Pigeon blue**  
RAL 5014



**D74/L74**  
**Ocean blue**  
Similar to RAL 5020



**D69/L69**  
**Light grey**  
Similar to RAL 7035



**D70/L70**  
**White aluminium**  
Similar to RAL 9006



**D75/L75**  
**Jet black**  
Similar to RAL 9005

### Note:

- The above selection of colours are shown in both melamine (D/Exx) and laminate (Lxx).
- If you order a product (e.g. Inform Search station) in two different colours from price group C, then please note that you will be charged two times the surcharge - one for each colour.

# DESIGN OPTIONS

## WOODEN COMPONENTS - VENEER

### **A** PRICE GROUP - BASIS PRICE



**55**  
Light steamed  
beech



**66**  
Oak



**67**  
Maple



**68**  
Ash



**69**  
Birch

#### **Note:**

- Table and work surfaces with solid wood veneer only have limited abrasion resistance. We recommend using HPL (which has a special overlay). For these types of surfaces, due to its higher durability against damages and scratches. Do not use veneer surfaces. If veneer is used for counter tops, we do not accept any complaints for damages or scratches.





# TECHNICAL SPECIFICATIONS

## STEEL COMPONENTS

are powder coated with standard polyester based powders that secures high UV resistance. Powders comply with EN 45545 (fire protection - similar to DIN 4201). Thickness of the coating is 60-80 µm.

The powder used includes:

- no triglycidylisocyanurate (TGIC)
- no heavy metal-containing pigments such as lead and cadmium
- no volatiles

Antibacterial equipping of surfaces upon request.

## LEG FRAMES

are made of steel section 40 x 40 x 2 mm and 40 x 20 x 2 mm and finished with a powder coat of thermo hardened polyester powder or epoxy (depending on choice of colour). Note: a leg frame is required per counter top in the same counter height.

## WOODEN COMPONENTS

are either melamine coated, high pressure laminated (HPL) or have a environmental-friendly transparent lacquered veneer finish. Differences in colour underline the characteristics of veneer and cannot be avoided. They conform to the norm EN 13986 of material type P2 and must only be used indoors. The border on each wooden panel is finished with an edge of melamine or with an edge of ABS (radius 2 mm). The edges are in the same colour of the wooden panels.

### SEARCH STATION AND DESK

are produced in 40 mm particle board and have a melamine/veneer finish.

### COUNTERS, SIDE- & MIDDLE PANELS, BAG SHELVES AND COUNTER SHELVES

are produced in 40 mm particle board and have a HPL finish.

### WOODEN CABINETS, COUNTER TOP PARTS AND DECORATIVE BOARDS

are produced in 19 mm particle board and have a melamine/veneer finish.

### STRAIGHT WOODEN FRONT PANELS FOR COUNTERS AND COUNTER SHELVES

are produced in 19 mm particle board and have a melamine/veneer finish.

### CURVED WOODEN FRONT PANELS FOR COUNTERS AND COUNTER SHELVES

are produced in 19 mm particle board and have a HPL finish.

### PLINTH

is produced in 19 mm particle board and has a melamin aluminum finish.

## ACRYLIC COMPONENTS

### ACRYLIC FRONT PANELS

are made of 5 mm acrylic glass panel, known as Plexiglas XT®. This material is conform with the EU norm EN 13501-1 (classification D like the German's norm DIN 4102-1)

## LIGHTING

### LIGHTING FOR COUNTER

You can add light under the counter with the use of an acrylic front panel. This light is only for use indoors and is conform with the norm 60598-1 ed 2000 + A 11 ed. 2000, EN 60598-2-1 Ed. 1998.

## CLEANING

Clean wooden-, metal- and acrylic surfaces with a damp cloth and wipe dry with a clean cloth. Use a water based cleaning agent. DO NOT USE A DETERGENT!

# INFORM SEARCH STATION

SINGLE- AND DOUBLE-SIDED



# INFORM SEARCH STATION

## SINGLE- AND DOUBLE-SIDED

Search station with offset keyboard and monitor levels. Place the CPU in the lockable cabinet with sufficient ventilation provided by the recoiling base and the air and cable conduct. Place freestanding monitor on the top level, alternately install a console for flat-screen monitors. The back wall/door can be ordered in different colours compared to the top/side panels.

### Inform search station - single-sided

Exterior: W750 x D625 x H1065 mm  
Interior: W670 x D260 x H740 mm  
With choice of desk grommet.

Material	Colour	Item no. Melamine	Item no. Veneer
Plastic	Black	BI610126	BI616122
Plastic	Oyster white	BI610186	BI616182
Plastic	Silver	BI610196	BI616192
Metal	Stainless steel	BI610136	BI616132

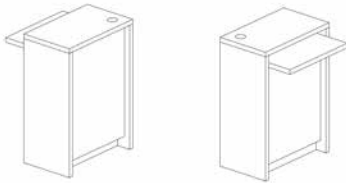

### Inform search station - double-sided

Exterior: W750 x D1200 x H1065 mm  
Interior: W670 x D610 x H740 mm

Material	Colour	Item no. Melamine	Item no. Veneer
Plastic	Black	BI610226	BI616222
Plastic	Oyster white	BI610286	BI616282
Plastic	Silver	BI610296	BI616292
Metal	Stainless steel	BI610236	BI616232



### Console for flat-screen monitor

Lacquered steel. Incl. mounting kit.  
Ideal for theft and tilt protection.

Item no.

B401418

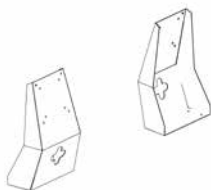

# INFORM DESK

SOLO

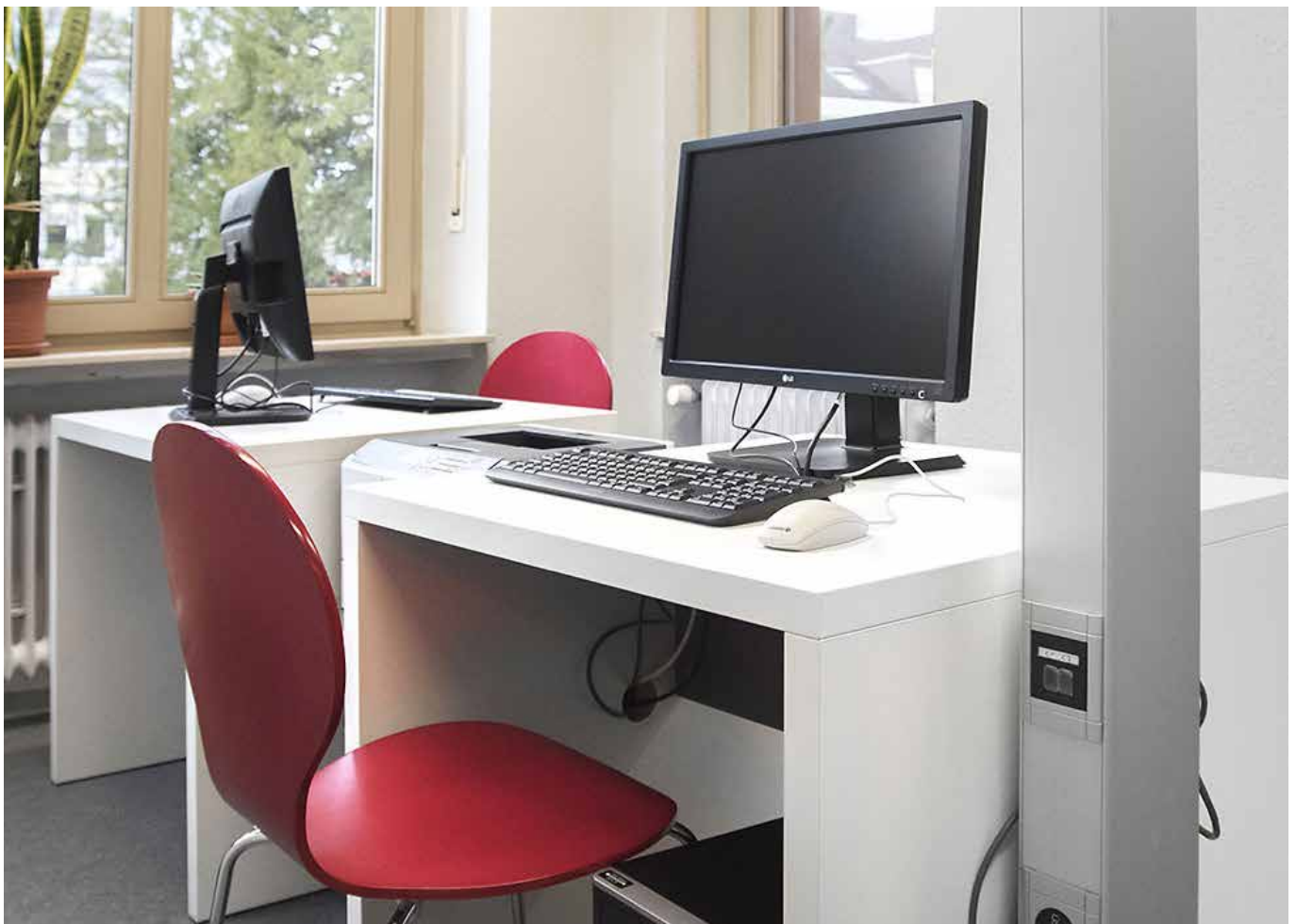

# INFORM DESK

SOLO

Create a private workspace and work on your own with the Solo freestanding rectangular desk. For accessories, see page 113.

## H740 mm - Rectangular table - freestanding - with panel (H305 mm) placed 50 mm from front

For counter with predrilled holes for cable conduct see pages 120-121.

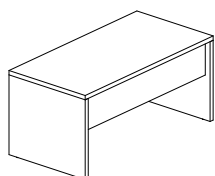

W x D mm	Item no. Melamine	Item no. Veneer
800 x 500	Bl620104006	Bl625104002
1000 x 500	Bl620114006	Bl625114002
1200 x 500	Bl620124006	Bl625124002
1400 x 500	Bl620134006	Bl625134002
1600 x 500	Bl620144006	Bl625144002
1800 x 500	Bl620154006	Bl625154002
800 x 600	Bl620204006	Bl625204002
1000 x 600	Bl620214006	Bl625214002
1200 x 600	Bl620224006	Bl625224002
1400 x 600	Bl620234006	Bl625234002
1600 x 600	Bl620244006	Bl625244002
1800 x 600	Bl620254006	Bl625254002
800 x 700	Bl620304006	Bl625304002
1000 x 700	Bl620314006	Bl625314002
1200 x 700	Bl620324006	Bl625324002
1400 x 700	Bl620334006	Bl625334002
1600 x 700	Bl620344006	Bl625344002
1800 x 700	Bl620354006	Bl625354002
800 x 800	Bl620404006	Bl625404002
1000 x 800	Bl620414006	Bl625414002
1200 x 800	Bl620424006	Bl625424002
1400 x 800	Bl620434006	Bl625434002
1600 x 800	Bl620444006	Bl625444002
1800 x 800	Bl620454006	Bl625454002

## H1000 mm - Rectangular table - freestanding - with panel (H305 mm) placed 50 mm from front

For counter with predrilled holes for cable conduct see pages 120-121.

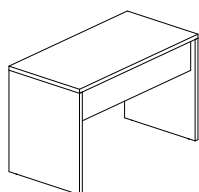

W x D mm	Item no. Melamine	Item no. Veneer
800 x 500	Bl620106006	Bl625106002
1000 x 500	Bl620116006	Bl625116002
1200 x 500	Bl620126006	Bl625126002
1400 x 500	Bl620136006	Bl625136002
1600 x 500	Bl620146006	Bl625146002
1800 x 500	Bl620156006	Bl625156002
800 x 600	Bl620206006	Bl625206002
1000 x 600	Bl620216006	Bl625216002
1200 x 600	Bl620226006	Bl625226002
1400 x 600	Bl620236006	Bl625236002
1600 x 600	Bl620246006	Bl625246002
1800 x 600	Bl620256006	Bl625256002
800 x 700	Bl620306006	Bl625306002
1000 x 700	Bl620316006	Bl625316002
1200 x 700	Bl620326006	Bl625326002
1400 x 700	Bl620336006	Bl625336002
1600 x 700	Bl620346006	Bl625346002
1800 x 700	Bl620356006	Bl625356002
800 x 800	Bl620406006	Bl625406002
1000 x 800	Bl620416006	Bl625416002
1200 x 800	Bl620426006	Bl625426002
1400 x 800	Bl620436006	Bl625436002
1600 x 800	Bl620446006	Bl625446002
1800 x 800	Bl620456006	Bl625456002

# INFORM TABLE

## DUO

Work opposite one another with the Duo freestanding, rectangular table. For accessories, see page 113.

### H740 mm - Rectangular table - freestanding - with panel (H305 mm) in the centre of table top

For counter with predrilled holes for cable conduct see pages 120-121.

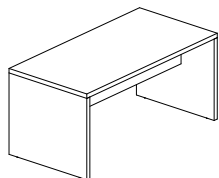

W x D mm	Item no. Melamine	Item no. Veneer
800 x 800	BI630404006	BI635404002
1000 x 800	BI630414006	BI635414002
1200 x 800	BI630424006	BI635424002
1400 x 800	BI630434006	BI635434002
1600 x 800	BI630444006	BI635444002
1800 x 800	BI630454006	BI635454002
800 x 1000	BI630504006	BI635504002
1000 x 1000	BI630514006	BI635514002
1200 x 1000	BI630524006	BI635524002
1400 x 1000	BI630534006	BI635534002
1000 x 1000	BI630544006	BI635544002
1800 x 1000	BI630554006	BI635554002
800 x 1200	BI630604006	BI635604002
1000 x 1200	BI630614006	BI635614002
1200 x 1200	BI630624006	BI635624002
1400 x 1200	BI630634006	BI635634002
1600 x 1200	BI630644006	BI635644002
1800 x 1200	BI630654006	BI635654002
800 x 1400	BI630704006	BI635704002
1000 x 1400	BI630714006	BI635714002
1200 x 1400	BI630724006	BI635724002
1400 x 1400	BI630734006	BI635734002
1600 x 1400	BI630744006	BI635744002
1800 x 1400	BI630754006	BI635754002
800 x 1600	BI630804006	BI635804002
1000 x 1600	BI630814006	BI635814002
1200 x 1600	BI630824006	BI635824002
1400 x 1600	BI630834006	BI635834002
1600 x 1600	BI630844006	BI635844002
1800 x 1600	BI630854006	BI635854002

# INFORM TABLE

DUO

Work opposite one another with the Duo freestanding, rectangular table. For accessories, see page 113.

## H1000 mm - Rectangular table - freestanding - with panel (H305 mm) in the centre of table top

For counter with predrilled holes for cable conduct see pages 120-121.

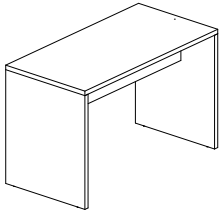

W x D mm	Item no. Melamine	Item no. Veneer
800 x 800	BI630406006	BI635406002
1000 x 800	BI630416006	BI635416002
1200 x 800	BI630426006	BI635426002
1400 x 800	BI630436006	BI635436002
1600 x 800	BI630446006	BI635446002
1800 x 800	BI630456006	BI635456002
800 x 1000	BI630506006	BI635506002
1000 x 1000	BI630516006	BI635516002
1200 x 1000	BI630526006	BI635526002
1400 x 1000	BI630536006	BI635536002
1000 x 1000	BI630546006	BI635546002
1800 x 1000	BI630556006	BI635556002
800 x 1200	BI630606006	BI635606002
1000 x 1200	BI630616006	BI635616002
1200 x 1200	BI630626006	BI635626002
1400 x 1200	BI630636006	BI635636002
1600 x 1200	BI630646006	BI635646002
1800 x 1200	BI630656006	BI635656002
800 x 1400	BI630706006	BI635706002
1000 x 1400	BI630716006	BI635716002
1200 x 1400	BI630726006	BI635726002
1400 x 1400	BI630736006	BI635736002
1600 x 1400	BI630746006	BI635746002
1800 x 1400	BI630756006	BI635756002
800 x 1600	BI630806006	BI635806002
1000 x 1600	BI630816006	BI635816002
1200 x 1600	BI630826006	BI635826002
1400 x 1600	BI630836006	BI635836002
1600 x 1600	BI630846006	BI635846002
1800 x 1600	BI630856006	BI635856002

# INFORM TABLE

DUO & TWIN





# INFORM TABLE

TWIN

Work or play? Create a fun and interesting - yet functional - sitting or standing area in the library with the Inform curved desk. For accessories, see page 113.

---

H740 mm - 2 x 90° curved tables - freestanding - with panel (H305 mm) in the centre of table top

Total length 3250 mm, total depth 1122 mm. For counter with predrilled holes for cable conduct see pages 120-121.

D  
mm  
800

Item no.  
Melamine  
BI64044006

Item no.  
Veneer  
BI64544002

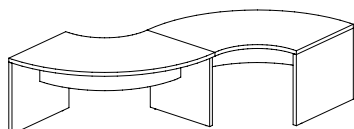

---

H1000 mm - 2 x 90° curved tables - freestanding - with panel (H305 mm) in the centre of table top

Total length 3250 mm, total depth 1122 mm. For counter with predrilled holes for cable conduct see pages 120-121.

D  
mm  
800

Item no.  
Melamine  
BI64046006

Item no.  
Veneer  
BI64546002

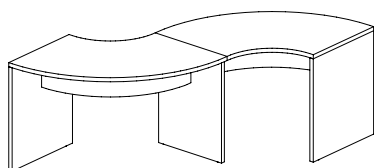

# INFORM COUNTER

Inform is a modular piece of furniture. Straight and curved elements can be used as freestanding counters or randomly combined. The special design of the table tops and side panels creates a continuous surrounding frame which unites the single elements into an expressive optical unit.

Inform's modular construction allows an individual adaptation to functional and design requirements, as well as to architectural conditions. You are able to reconstruct and add on as well as electrically adjust the counter to your ideal working height. Modules in the two heights; 740 and 1000 mm can be combined in many ways. The counter is also suitable for use with RFID systems.

## CONSTRUCTION

The construction of the counter Inform is based on a left-to-right sequence (seen from the person's view sitting behind the counter). The counter has 15 mm adjustable feet.

## MOUNTING TOLERANCES

All our components for the Inform counter are produced according to the norm DIN ISO 2768-1.

## ASSEMBLY

No special fittings or tools are needed.

## DIMENSIONS

For planning purposes, please note the below measurements. The listed measurements in the catalogue/price list are the effective measurements for the front panels only. It is necessary to add 40 mm with all the side/end panels, step counter middle panels and middle panels in connection with height adjustable counters.

### STARTER-, MIDDLE- & END ELEMENT

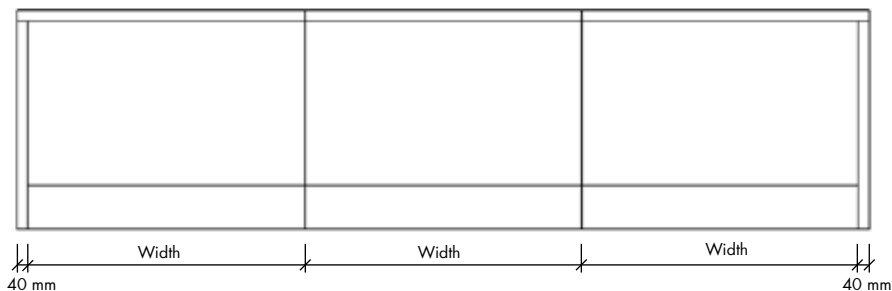

### STEP COUNTER

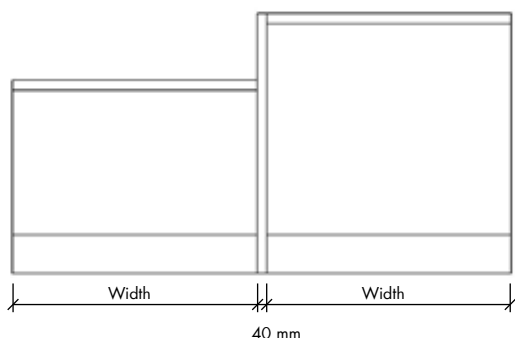

### HEIGHT ADJUSTABLE COUNTER

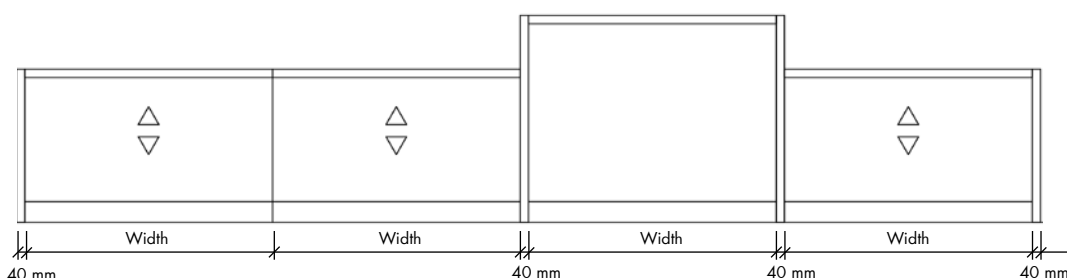

# CONFIGURATION OPTIONS

## RECTANGULAR COUNTERS

W 600/800/1000/1200/1400/1600 mm (+40 mm per outer panel)  
 H 740/1000 mm  
 D 800 mm

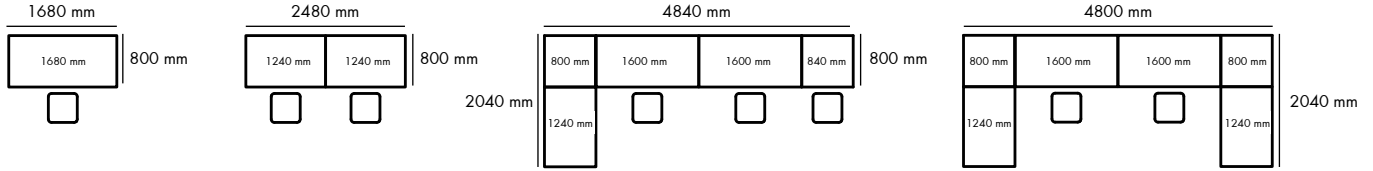

## CURVED COUNTERS 45° & 90°

Height:	740 mm	Height:	740 mm
Inside radius:	1550 mm	Inside radius:	500 mm
Outer radius:	2350 mm	Outer radius:	1300 mm

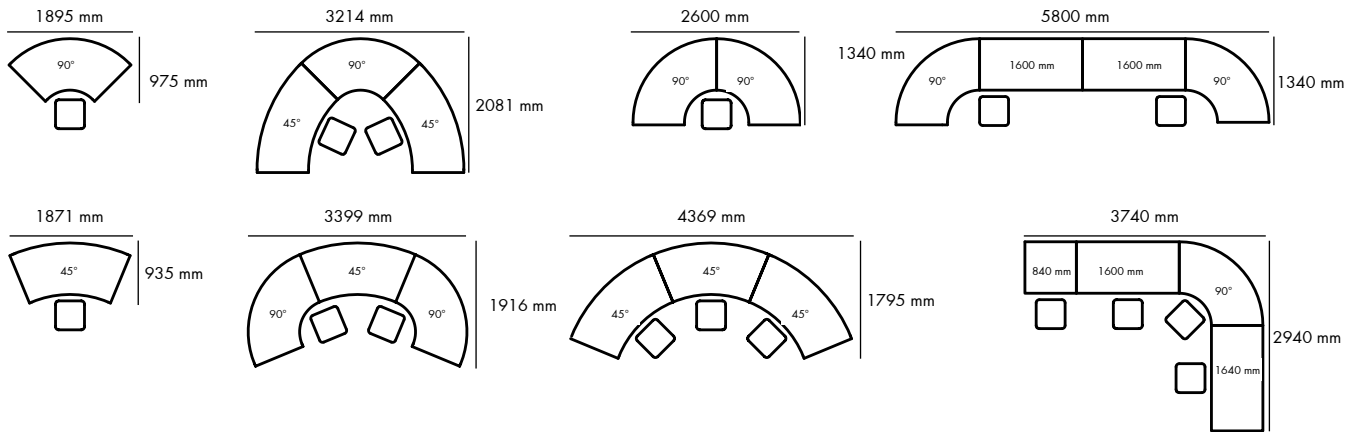

## RECTANGULAR AND CURVED COUNTERS WITH VARIOUS INTEGRATED CABINETS/COUNTERS

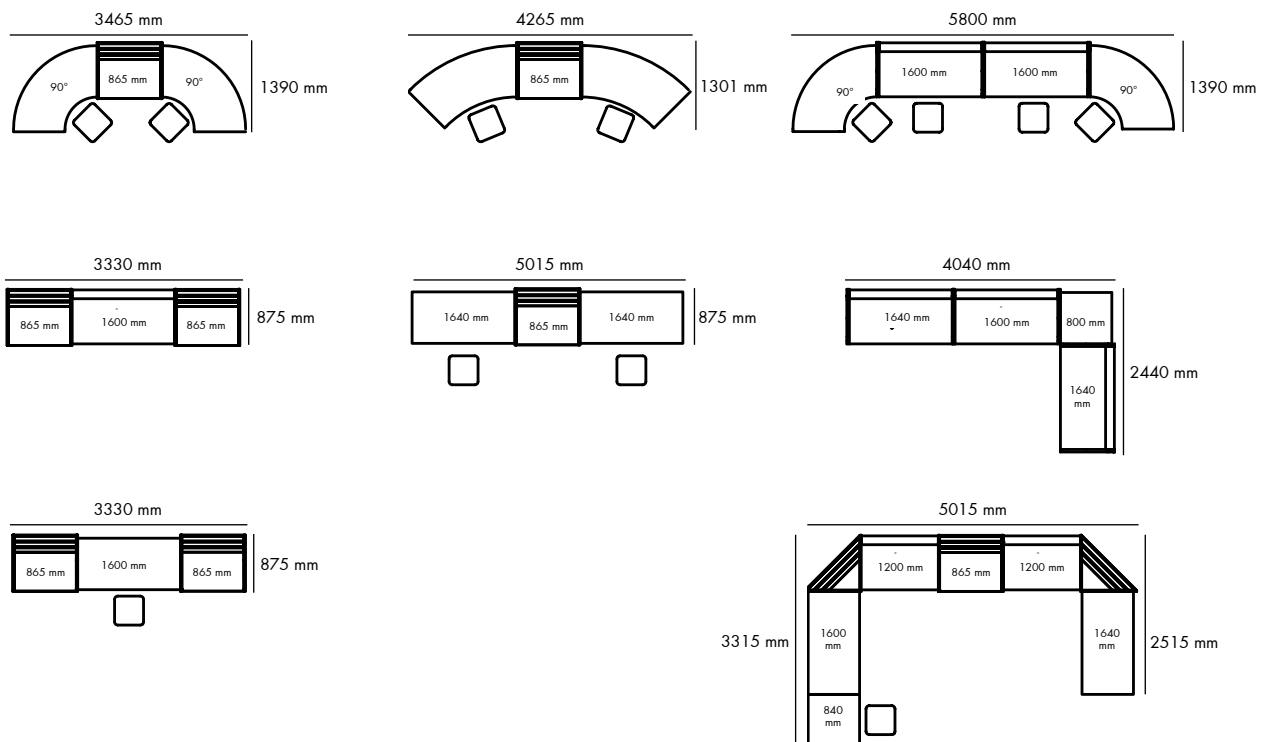

# STANDARD COUNTER

CONFIGURATION NO. 1

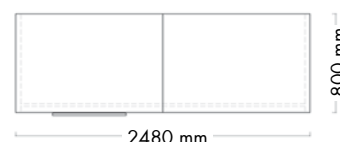

## Rectangular counter (with info sign)

Components	Article no.	Quantity		
Rectangular counter - starter (W1240 x H740 mm)	BI2001022003	-	1	-
Rectangular counter - end (W1240 x H740 mm)	BI2003022003	-	1	-
Wooden front panel for rectangular counter (W1200 x H740 mm)	BI300546	-	2	-
Steel leg frame (H740 mm)	BI069146	-	1	-
Info sign - acrylic frosted white glazed (W600 x H430 mm)	BI85512	-	1	-
Monitor arm	B401184	-	1	-

### Comments to configuration

- Monitor, office chair and text are not included in price.
- All prices are based on colours and surfaces in price group A, see pages 4-7 for colours.
- We recommend the use of desk grommets, cable rails and drawer pedestals with the Inform counter, see page 113.
- It is necessary to drill an Ø80 mm hole for the monitor arm on site or modify the article number for counter for predrilled hole, see pages 120-121.

# STANDARD COUNTER

CONFIGURATION NO. 2

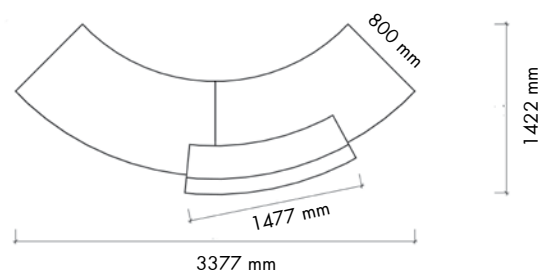

## 45° curved counters (with counter top part with bag shelf)

Components	Article no.	Quantity		
45° curved counter - starter (H740 mm)	BI2051428003	-	1	-
45° curved counter - end (H740 mm)	BI2053428003	-	1	-
Wooden front panel for 45° curved counter (H740 mm)	BI3204543	-	2	-
Steel leg frame (H740 mm)	BI069146	-	1	-
Wooden counter top part with bag shelf (W1400 x H490 mm)	BI83545683	-	1	-

### Comments to configuration

- Computer, office chair and text are not included in price.
- All prices are based on colours and surfaces in price group A, see pages 4-7 for colours.
- We recommend the use of desk grommets, cable rails and drawer pedestals with the Inform counter, see page 113.

# STANDARD COUNTER

## RECTANGULAR COUNTER

Inform's rectangular modules are available in two heights; 740 and 1000 mm. This model can be combined with other standard counters of the same height, step counters, height adjustable counters (only with H1000 mm standard counter), info counters, corner counters as well as display cabinets.

### Rectangular counter - starter

Remember to order front panel, see page 23 and leg frame/middle panel, see page 34. For counter with predrilled holes for cable conduct see pages 120-121.

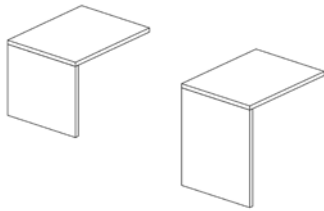

H	x	W	x	D	Item no.
mm					HPL
740	640	800			BI2001016003
740	840	800			BI2001018003
740	1040	800			BI2001020003
740	1240	800			BI2001022003
740	1440	800			BI2001024003
740	1640	800			BI2001026003
1000	640	800			BI2001036003
1000	840	800			BI2001038003
1000	1040	800			BI2001040003
1000	1240	800			BI2001042003
1000	1440	800			BI2001044003
1000	1640	800			BI2001046003

### Rectangular counter - middle

Remember to order front panel, see page 23 and leg frame/middle panel, see page 34. For counter with predrilled holes for cable conduct see pages 120-121.

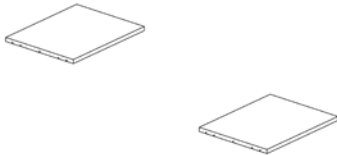

W	x	D	Item no.
mm			HPL
600	800		BI2002060003
800	800		BI2002080003
1000	800		BI2002081003
1200	800		BI2002082003
1400	800		BI2002084003
1600	800		BI2002086003

### Rectangular counter - end

Remember to order front panel, see page 23 and leg frame/middle panel, see page 34. For counter with predrilled holes for cable conduct see pages 120-121.

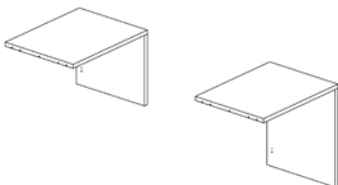

H	x	W	x	D	Item no.
mm					HPL
740	640	800			BI2003016003
740	840	800			BI2003018003
740	1040	800			BI2003020003
740	1240	800			BI2003022003
740	1440	800			BI2003024003
740	1640	800			BI2003026003
1000	640	800			BI2003036003
1000	840	800			BI2003038003
1000	1040	800			BI2003040003
1000	1240	800			BI2003042003
1000	1440	800			BI2003044003
1000	1640	800			BI2003046003

# STANDARD COUNTER

## FREESTANDING RECTANGULAR COUNTER AND FRONT PANELS

A freestanding rectangular counter is an ideal solution for small rooms and is available in two heights; 740 and 1000 mm. Remember to order front panels.

### Rectangular counter - freestanding

Remember to order front panel. For counter with predrilled holes for cable conduct see pages 120-121.

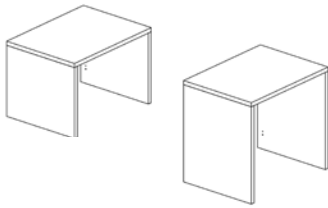

H x W x D mm	Item no. HPL
740 680 800	BI2004016003
740 880 800	BI2004018003
740 1080 800	BI2004020003
740 1280 800	BI2004022003
740 1480 800	BI2004024003
740 1680 800	BI2004026003
1000 680 800	BI2004036003
1000 880 800	BI2004038003
1000 1080 800	BI2004040003
1000 1280 800	BI2004042003
1000 1480 800	BI2004044003
1000 1680 800	BI2004046003

### Wooden front panel for rectangular counter

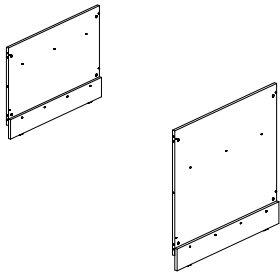

H x W mm	Item no. Melamine	Item no. Veneer
740 600	BI300146	BI300142
740 800	BI300346	BI300342
740 1000	BI300446	BI300442
740 1200	BI300546	BI300542
740 1400	BI300646	BI300642
740 1600	BI300746	BI300742
1000 600	BI300166	BI300162
1000 800	BI300366	BI300362
1000 1000	BI300466	BI300462
1000 1200	BI300566	BI300562
1000 1400	BI300666	BI300662
1000 1600	BI300766	BI300762

### Acrylic front panel for rectangular counter

Melamine coated wooden frame.

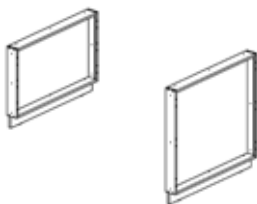

H x W mm	Item no. Acrylic & melamine
740 600	BI310146
740 800	BI310346
740 1000	BI310446
740 1200	BI310546
740 1400	BI310646
740 1600	BI310746
1000 600	BI310166
1000 800	BI310366
1000 1000	BI310466
1000 1200	BI310566
1000 1400	BI310666
1000 1600	BI310766

# STANDARD COUNTER

## 45° CURVED COUNTERS

Inform's 45° curved modules are available in two heights; 740 and 1000 mm. This model can be combined with other standard counters of the same height, step counters, height adjustable counters (only with H1000 mm standard counter), info counters, corner counters as well as display cabinets.

### 45° curved counter - starter

Remember to order front panel, see page 25 and leg frame/middle panel, see page 34. For counter with predrilled holes for cable conduct see pages 120-121.

H	x	W	x	D
mm				
740	1835	800		
1000	1835	800		

Item no.
HPL
BI2051428003
BI2051448003

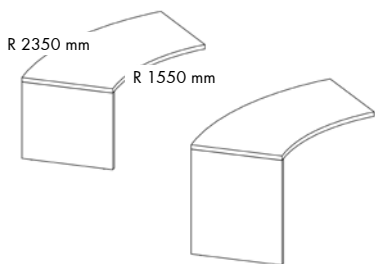

### 45° curved counter - middle

Remember to order front panel, see page 25 and leg frame/middle panel, see page 34. For counter with predrilled holes for cable conduct see pages 120-121.

W	x	D
mm		
1800	800	

Item no.
HPL
BI2052488003



### 45° curved counter - end

Remember to order front panel, see page 25 and leg frame/middle panel, see page 34. For counter with predrilled holes for cable conduct see pages 120-121.

H	x	W	x	D
mm				
740	1835	800		
1000	1835	800		

Item no.
HPL
BI2053428003
BI2053448003

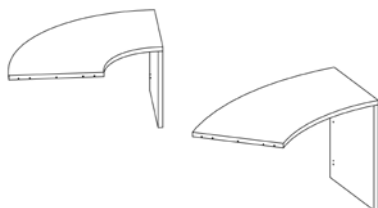



# STANDARD COUNTER

## FREESTANDING 45° CURVED COUNTERS AND FRONT PANELS

A freestanding 45° curved counter is an ideal solution for small rooms and is available in two heights; 740 and 1000 mm. Remember to order front panels.

### 45° curved counter - freestanding

Remember to order front panel. For counter with predrilled holes for cable conduct see pages 120-121.

H	x	W	x	D
mm				
740		1870		800
1000		1870		800

Item no.
HPL
BI2054428003
BI2054448003

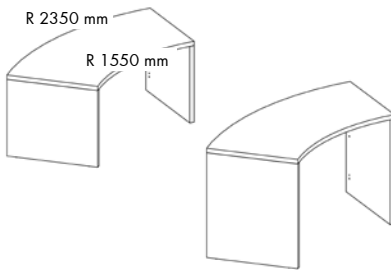

### Wooden front panel for 45° curved counter

H	x	W
mm		
740		1760
1000		1760

Item no.
HPL
BI3204543
BI3204563

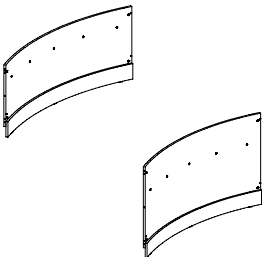

### Acrylic front panel for 45° curved counter

Melaminecoated wooden frame.

H	x	W
mm		
740		1760
1000		1760

Item no.
Acrylic & melamine
BI3304546
BI3304566

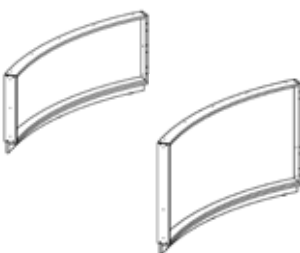

# STANDARD COUNTER

## 90° CURVED COUNTERS

Inform's 90° curved modules are available in two heights; 740 and 1000 mm. This model can be combined with other standard counters of the same height, step counters, height adjustable counters (only with H1000 mm standard counter), info counters, corner counters as well as display cabinets.

### 90° curved counter - starter

Remember to order front panel, see page 27 and leg frame/middle panel, see page 34. For counter with predrilled holes for cable conduct see pages 120-121.

H	x	W	x	D
mm				
740	1870	800		
1000	1870	800		

Item no.
HPL
BI2051928003
BI2051948003

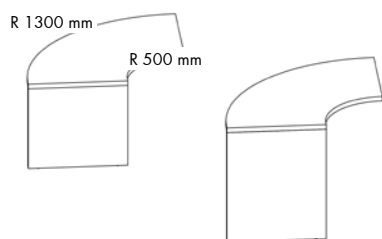

### 90° curved counter - middle

Remember to order front panel, see page 27 and leg frame/middle panel, see page 34. For counter with predrilled holes for cable conduct see pages 120-121.

W	x	D
mm		
1800	800	

Item no.
HPL
BI2052988003



### 90° curved counter - end

Remember to order front panel, see page 27 and leg frame/middle panel, see page 34. For counter with predrilled holes for cable conduct see pages 120-121.

H	x	W	x	D
mm				
740	1870	800		
1000	1870	800		

Item no.
HPL
BI2053928003
BI2053948003

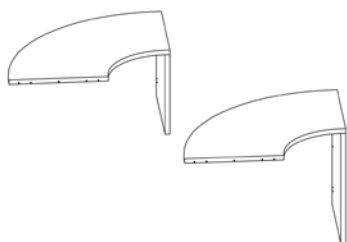

# STANDARD COUNTERS

## FREESTANDING 90° CURVED COUNTERS AND FRONT PANELS

A freestanding 90° curved counter is an ideal solution for small rooms and is available in two heights; 740 and 1000 mm. Remember to order front panels.

### 90° curved counter - freestanding

Remember to order front panel. For counter with predrilled holes for cable conduct see pages 120-121.

H	x	W	x	D
mm				
740		1900		800
1000		1900		800

Item no.
HPL
BI2054928003
BI2054948003

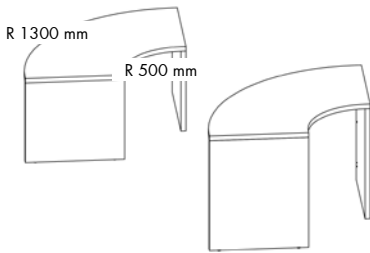

### Wooden front panel for 90° curved counter

H	x	W
mm		
740		1768
1000		1768

Item no.
HPL
BI3209043
BI3209063

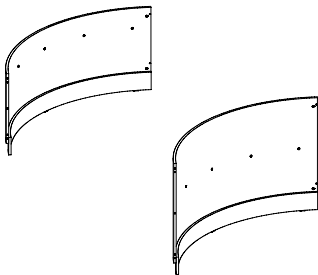

### Acrylic front panel for 90° curved counter

Melaminecoated wooden frame.

H	x	W
mm		
740		1768
1000		1768

Item no.
Acrylic & melamine
BI3309046
BI3309066

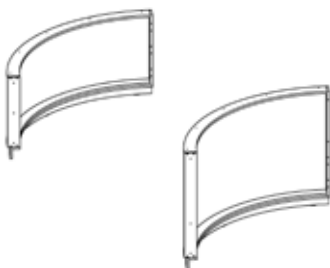

# STANDARD COUNTER

## RECTANGULAR COUNTERS - FOR CONNECTING TO RECESSED COUNTER

Inform's rectangular modules are available in two heights; 740 and 1000 mm. This model can be combined with recessed counters of the same height as the standard counter by connecting with a middle panel (as the counter top is 40 mm wider than the standard rectangular counter).

### Rectangular counter - starter - connected with middle panel

Remember to order front panel, see page 29 and middle panel, see page 34. For counter with predrilled holes for cable conduct see pages 120-121.

H	x	W	x	D
mm				
740	680	800		
740	880	800		
740	1080	800		
740	1280	800		
740	1480	800		
740	1680	800		
1000	680	800		
1000	880	800		
1000	1080	800		
1000	1280	800		
1000	1480	800		
1000	1680	800		

Item no.
HPL
BI2021016003
BI2021018003
BI2021020003
BI2021022003
BI2021024003
BI2021026003
BI2021036003
BI2021038003
BI2021040003
BI2021042003
BI2021044003
BI2021046003

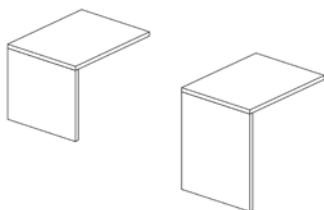

### Rectangular counter - middle - connected with middle panel

Remember to order front panel, see page 29 and middle panel, see page 34. For counter with predrilled holes for cable conduct see pages 120-121.

W	x	D
mm		
640	800	
840	800	
1040	800	
1240	800	
1440	800	
1640	800	

Item no.
HPL
BI2022060003
BI2022080003
BI2022081003
BI2022082003
BI2022084003
BI2022086003

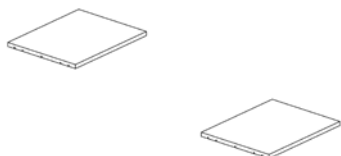

### Rectangular counter - end - connected with middle panel

Remember to order front panel, see page 29 and middle panel, see page 34. For counter with predrilled holes for cable conduct see pages 120-121.

H	x	W	x	D
mm				
740	680	800		
740	880	800		
740	1080	800		
740	1280	800		
740	1480	800		
740	1680	800		
1000	680	800		
1000	880	800		
1000	1080	800		
1000	1280	800		
1000	1480	800		
1000	1680	800		

Item no.
HPL
BI2023016003
BI2023018003
BI2023020003
BI2023022003
BI2023024003
BI2023026003
BI2023036003
BI2023038003
BI2023040003
BI2023042003
BI2023044003
BI2023046003

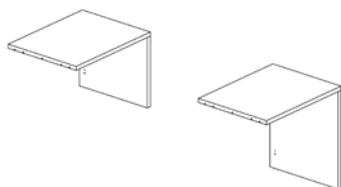

# STANDARD COUNTER

## RECTANGULAR FRONT PANELS

Remember to order front panels.

### Wooden front panel for rectangular counter

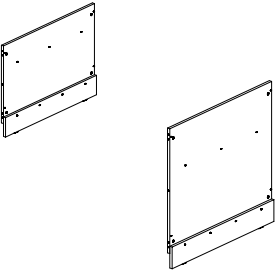
	H x W mm	Item no.	Item no.
		Melamine	Veneer
	740 600	BI300146	BI300142
	740 800	BI300346	BI300342
	740 1000	BI300446	BI300442
	740 1200	BI300546	BI300542
	740 1400	BI300646	BI300642
	740 1600	BI300746	BI300742
	1000 600	BI300166	BI300162
	1000 800	BI300366	BI300362
	1000 1000	BI300466	BI300462
	1000 1200	BI300566	BI300562
	1000 1400	BI300666	BI300662
	1000 1600	BI300766	BI300762

### Acrylic front panel for rectangular counter

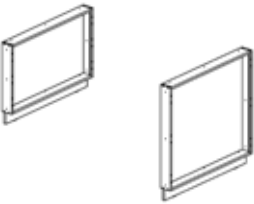
Melaminecoated wooden frame.	H x W mm	Item no.
		Acrylic & Melamine
	740 600	BI310146
	740 800	BI310346
	740 1000	BI310446
	740 1200	BI310546
	740 1400	BI310646
	740 1600	BI310746
	1000 600	BI310166
	1000 800	BI310366
	1000 1000	BI310466
	1000 1200	BI310566
	1000 1400	BI310666
	1000 1600	BI310766

# STANDARD COUNTER

## 45° CURVED COUNTERS - FOR CONNECTING TO RECESSED COUNTER

Inform's° curved modules are available in two heights; 740 and 1000 mm. This model can be combined with recessed counters of the same height as the standard counter by connecting with a middle panel (as the counter top is 40 mm wider than the standard 45° curved counter).

### 45° curved counter - starter - connected with middle panel

Remember to order front panel, see page 31 and middle panel, see page 34. For counter with predrilled holes for cable conduct see pages 120-121.

H	x	W	x	D
mm				
740	-	800		
1000	-	800		

Item no.
HPL
BI2061428003
BI2061448003

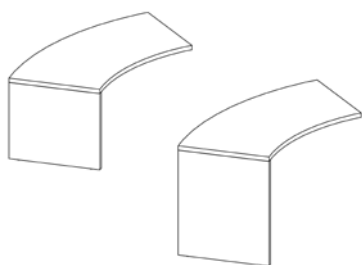

### 45° curved counter - end - for middle panel

Remember to order front panel, see page 31 and middle panel, see page 34. For counter with predrilled holes for cable conduct see pages 120-121.

H	x	W	x	D
mm				
740	-	800		
1000	-	800		

Item no.
HPL
BI2063428003
BI2063448003

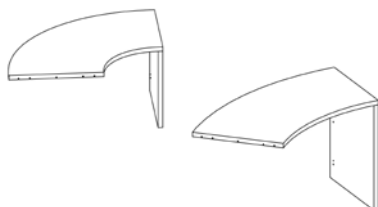

# STANDARD COUNTER

## 45° CURVED FRONT PANELS

Remember to order front panels.

---

### Wooden front panel for 45° curved counter

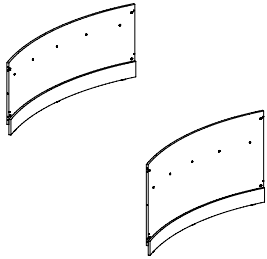

H	x	W
mm		
740		1760
1000		1760

Item no.
HPL
BI3204543
BI3204563

---

### Acrylic front panel for 45° curved counter

Melaminecoated wooden frame.

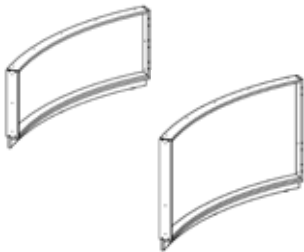

H	x	W
mm		
740		1760
1000		1760

Item no.
Acrylic & melamine
BI3304546
BI3304566

# STANDARD COUNTER

## 90° CURVED COUNTERS - FOR CONNECTING TO RECESSED COUNTER

Inform's 90° curved modules are available in two heights; 740 and 1000 mm. This model can be combined with recessed counters of the same height as the standard counter by connecting with a middle panel (as the counter top is 40 mm wider than the standard 90° curved counter).

### 90° curved counter - starter - connected with middle panel

Remember to order front panel, see page 33 and middle panel, see page 34. For counter with predrilled holes for cable conduct see pages 120-121.

H	x	W	x	D
mm				
740	-	800		
1000	-	800		

Item no.
HPL
BI2061928003
BI2061948003

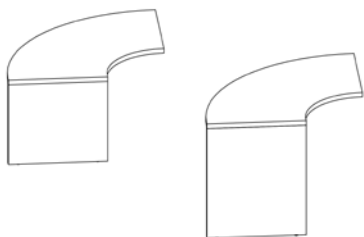

### 90° curved counter - end - connected with middle panel

Remember to order front panel, see page 33 and middle panel, see page 34. For counter with predrilled holes for cable conduct see pages 120-121.

H	x	W	x	D
mm				
740	-	800		
1000	-	800		

Item no.
HPL
BI2063928003
BI2063948003

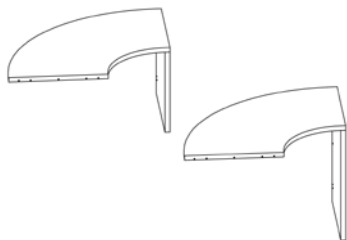



# STANDARD COUNTERS

## 90° CURVED FRONT PANELS

Remember to order front panels.

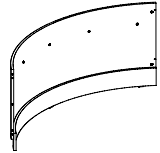
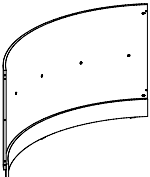

---

### Wooden front panel for 90° curved counter

	H x W mm	Item no. HPL
	740 1768	BI3209043
	1000 1768	BI3209063

---

### Acrylic front panel for 90° curved counter

Melaminecoated wooden frame.	H x W mm	Item no. Acrylic & melamine
	740 1768	BI3309046
	1000 1768	BI3309066

# STANDARD COUNTER

## CONNECTIONS

If you wish to combine a rectangular/curved counter with a rectangular/curved counter of the same height, you must use a steel leg frame.

If you wish to combine a rectangular/curved counter with recessed rectangular/curved or step counter, you must use a middle panel.

### Steel leg frame

Must be used when assembling 2 modules of the same height.

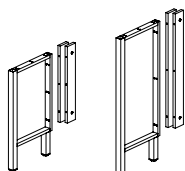

Finish	H mm	Item no. Melamine/veneer
Melamine	740	BI069146
	1000	BI069166
Veneer	740	BI069142
	1000	BI069162

### Middle panel for standard and recessed counter

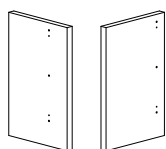

Side of panel	H mm	Item no. HPL
Left : Recessed counter Right: Standard counter	740	BI3704103

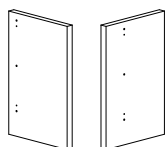

Left: Standard counter Right: Recessed counter	740	BI3704113
---	-----	-----------

### Middle panel for standard and step counter

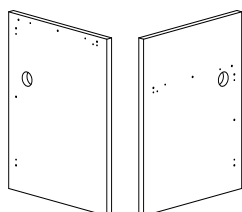

Side of panel	H mm	Item no. HPL
Left: Step counter Right: Standard counter (H740 mm)	1000	BI3706123

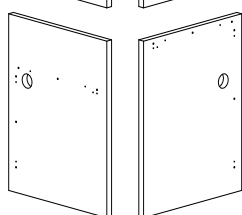

Left: Standard counter (H740 mm) Right: Step counter	1000	BI3706133
---	------	-----------

# STANDARD COUNTER

## CONFIGURATIONS

Remember always to construct your counter from left to right when sitting behind the counter.

---

Standard rectangular counter with 3 standard fronts and 1 recessed front

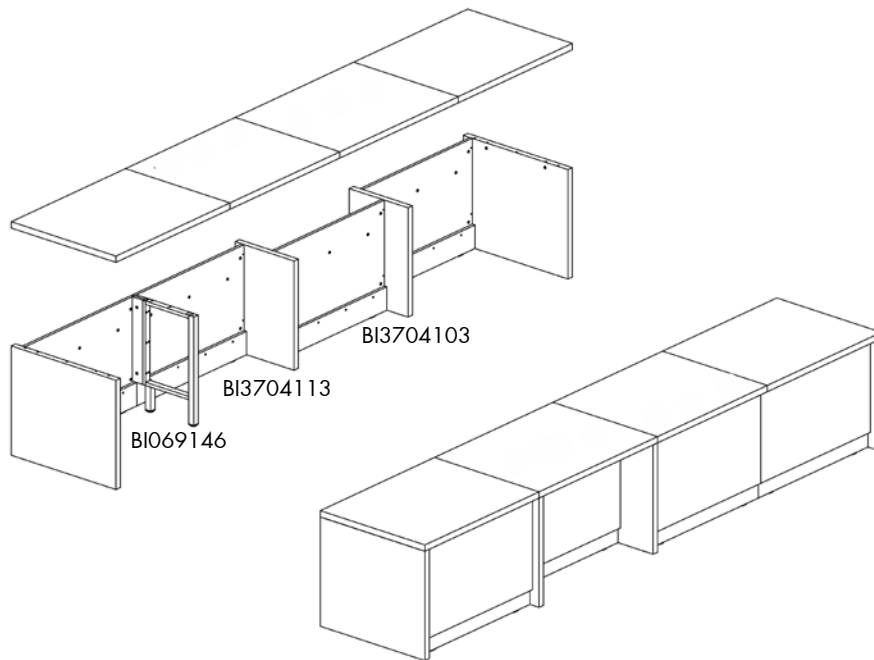

---

Standard rectangular and step counters

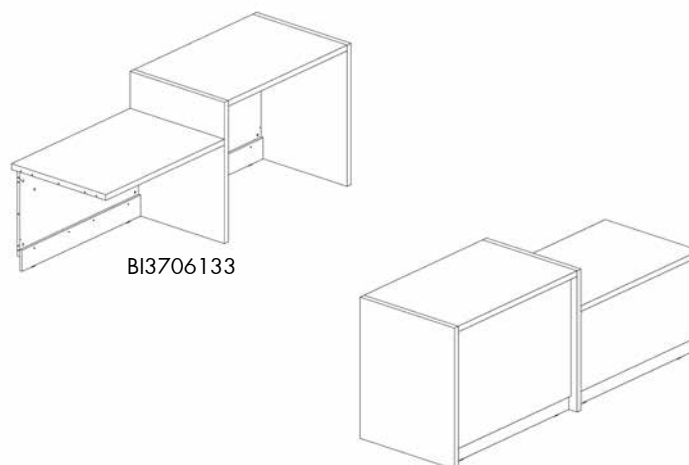

# RECESSED COUNTER

CONFIGURATION NO. 3

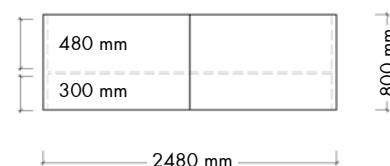

## Recessed rectangular counter

Components	Article no.	Quantity		
Recessed rectangular counter - starter (W1240 x H740 mm)	BI2101022003	-	1	-
Recessed rectangular counter - end (W1240 x H740 mm)	BI2103022003	-	1	-
Wooden front panel for rectangular counter (W1200 x H740 mm)	BI300546	-	2	-
Steel leg frame for recessed counter (H740 mm)	BI069546	-	1	-
<b>Total price for configuration</b>				-

### Comments to configuration

- Monitor, office chair and text are not included in price.
- All prices are based on colours and surfaces in price group A, see pages 4-7 for colours.
- We recommend the use of desk grommets, cable rails and drawer pedestals with the Inform counter, see page 113.

# RECESSED COUNTER

CONFIGURATION NO. 4

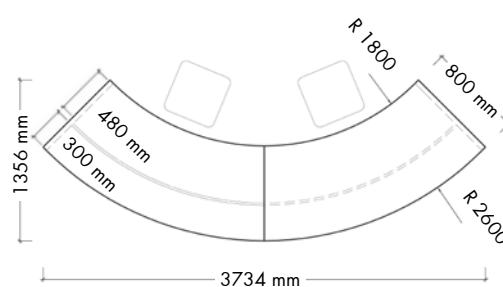

## Recessed 45° curved counter

Components	Article no.	Quantity		
45° recessed curved counter - starter (H740 mm)	BI2151429003	-	1	-
45° recessed curved counter - end (H740 mm)	BI2153429003	-	1	-
Wooden front panel for 45° curved counter (H740 mm)	BI3204543	-	2	-
Steel leg frame for recessed counter (H740 mm)	BI069546	-	1	-
<b>Total price for configuration</b>				-

### Comments to configuration

- Computer, office chair, display and text are not included in price.
- All prices are based on colours and surfaces in price group A, see pages 4-7 for colours.
- We recommend the use of desk grommets, cable rails and drawer pedestals with the Inform counter, see page 113.

# RECESSED COUNTER

## RECTANGULAR COUNTERS

The design of Inform's recessed front panel allows for easy access on both sides of the counter and is especially suited for wheelchair use, as the front panel is placed 300 mm from the front. It is available in two heights; 740 and 1000 mm. This model can be combined with other recessed counters of the same height, step counters, height adjustable counters (only with H1000 mm standard counter), info counters, corner counters as well as display cabinets.

### Recessed rectangular counter - starter

Remember to order front panel, see page 39 and leg frame/middle panel, see page 50. For counter with predrilled holes for cable conduct see pages 120-121.

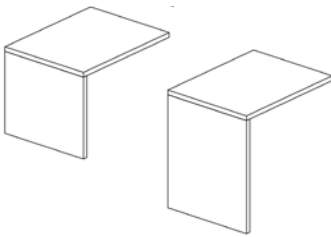

H x W x D mm	Item no. HPL
740 640 800	BI2101016003
740 840 800	BI2101018003
740 1040 800	BI2101020003
740 1240 800	BI2101022003
740 1440 800	BI2101024003
740 1640 800	BI2101026003
1000 640 800	BI2101036003
1000 840 800	BI2101038003
1000 1040 800	BI2101040003
1000 1240 800	BI2101042003
1000 1440 800	BI2101044003
1000 1640 800	BI2101046003

### Recessed rectangular counter - middle

Remember to order front panel, see page 39 and leg frame/middle panel, see page 50. For counter with predrilled holes for cable conduct see pages 120-121.

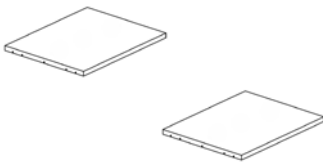

W x D mm	Item no. HPL
600 800	BI2102060003
800 800	BI2102080003
1000 800	BI2102081003
1200 800	BI2102082003
1400 800	BI2102084003
1600 800	BI2102086003

### Recessed rectangular counter - end

Remember to order front panel, see page 39 and leg frame/middle panel, see page 50. For counter with predrilled holes for cable conduct see pages 120-121.

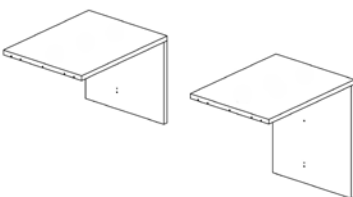

H x W x D mm	Item no. HPL
740 640 800	BI2103016003
740 840 800	BI2103018003
740 1040 800	BI2103020003
740 1240 800	BI2103022003
740 1440 800	BI2103024003
740 1640 800	BI2103026003
1000 640 800	BI2103036003
1000 840 800	BI2103038003
1000 1040 800	BI2103040003
1000 1240 800	BI2103042003
1000 1440 800	BI2103044003
1000 1640 800	BI2103046003

# RECESSED COUNTER

## FREESTANDING RECTANGULAR COUNTERS AND FRONT PANELS

The design of Inform's recessed front panel allows for easy access on both sides of the counter and is especially suited for wheelchair use, as the front panel is placed 300 mm from the front. Remember to order front panel.

### Recessed rectangular counter - freestanding

Remember to order front panel. For counter with predrilled holes for cable conduct see pages 120-121.

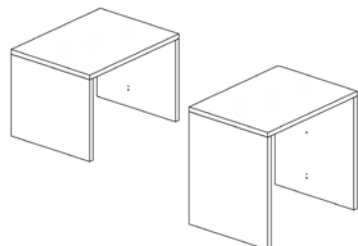

H x W x D mm	Item no. HPL
740 680 800	BI2104016003
740 880 800	BI2104018003
740 1080 800	BI2104020003
740 1280 800	BI2104022003
740 1480 800	BI2104024003
740 1680 800	BI2104026003
1000 680 800	BI2104036003
1000 880 800	BI2104038003
1000 1080 800	BI2104040003
1000 1280 800	BI2104042003
1000 1480 800	BI2104044003
1000 1680 800	BI2104046003

### Wooden front panel for recessed rectangular counter

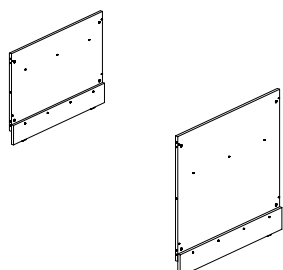

H x W mm	Item no. Melamine	Item no. Veneer
740 600	BI300146	BI300142
740 800	BI300346	BI300342
740 1000	BI300446	BI300442
740 1200	BI300546	BI300542
740 1400	BI300646	BI300642
740 1600	BI300746	BI300742
1000 600	BI300166	BI300162
1000 800	BI300366	BI300362
1000 1000	BI300466	BI300462
1000 1200	BI300566	BI300562
1000 1400	BI300666	BI300662
1000 1600	BI300766	BI300762

### Acrylic front panel for recessed rectangular counter

Melaminecoated wooden frame.

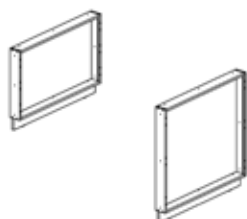

H x W mm	Item no. Acrylic & melamine
740 600	BI310146
740 800	BI310346
740 1000	BI310446
740 1200	BI310546
740 1400	BI310646
740 1600	BI310746
1000 600	BI310166
1000 800	BI310366
1000 1000	BI310466
1000 1200	BI310566
1000 1400	BI310666
1000 1600	BI310766

# RECESSED COUNTER

## 45° CURVED COUNTERS

The design of Inform's recessed front panel allows for easy access on both sides of the counter and is especially suited for wheelchair use, as the front panel is placed 300 mm from the front. It is available in two heights; 740 and 1000 mm. This model can be combined with other recessed counters of the same height, step counters, height adjustable counters (only with H1000 mm standard counter), info counters, corner counters as well as display cabinets.

### 45° recessed curved counter - starter

Remember to order front panel, see page 41 and leg frame/middle panel, see page 50. For counter with predrilled holes for cable conduct see pages 120-121.

H	x	W	x	D
mm				
740		2030		800
1000		2030		800

Item no.
HPL
BI2151429003
BI2151449003

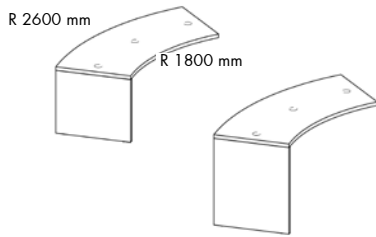

### 45° recessed curved counter - middle

Remember to order front panel, see page 41 and leg frame/middle panel, see page 50. For counter with predrilled holes for cable conduct see pages 120-121.

W	x	D
mm		
1800		800

Item no.
HPL
BI2152489003

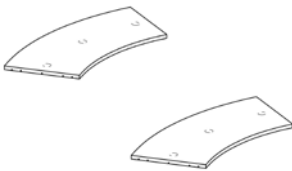

### 45° recessed curved counter - end

Remember to order front panel, see page 41 and leg frame/middle panel, see page 50. For counter with predrilled holes for cable conduct see pages 120-121.

H	x	W	x	D
mm				
740		2030		800
1000		2030		800

Item no.
HPL
BI2153429003
BI2153449003

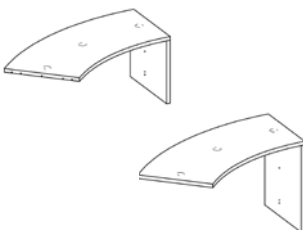



# RECESSED COUNTER

## FREESTANDING 45° CURVED COUNTERS AND FRONT PANELS

The design of Inform's recessed front panel allows for easy access on both sides of the counter and is especially suited for wheelchair use, as the front panel is placed 300 mm from the front. Remember to order front panel.

### 45° recessed curved counter - freestanding

Remember to order front panel. For counter with predrilled holes for cable conduct see pages 120-121.

H	x	W	x	D
mm				
740		2070		800
1000		2070		800

Item no.
HPL
BI2154429003
BI2154449003

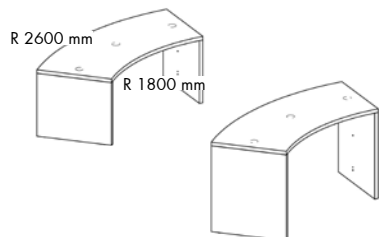

### Wooden front panel for 45° recessed curved counter

H	x	W
mm		
740		1760
1000		1760

Item no.
HPL
BI3204543
BI3204563

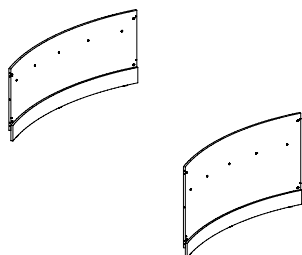

### Acrylic front panel for 45° recessed curved counter

Melaminecoated wooden frame.

H	x	W
mm		
740		1760
1000		1760

Item no.
Acrylic & melamine
BI3304546
BI3304566

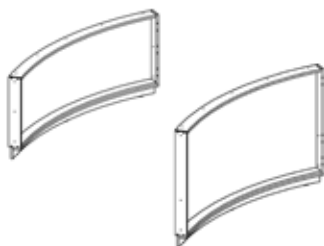

# RECESSED COUNTER

## 90° CURVED COUNTERS

The design of Inform's recessed front panel allows for easy access on both sides of the counter and is especially suited for wheelchair use, as the front panel is placed 300 mm from the front. It is available in two heights; 740 and 1000 mm. This model can be combined with other recessed counters of the same height, step counters, height adjustable counters (only with H1000 mm standard counter), info counters, corner counters as well as display cabinets.

### 90° recessed curved counter - starter

Remember to order front panel, see page 43 and leg frame/middle panel, see page 50. For counter with predrilled holes for cable conduct see pages 120-121.

H	x	W	x	D
mm				
740		2220		800
1000		2220		800

Item no.
HPL
BI2151929003
BI2151949003

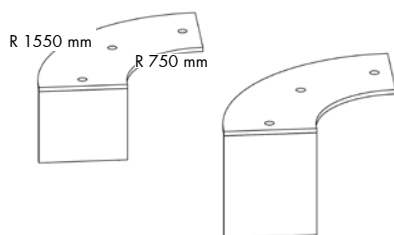

### 90° recessed curved counter - middle

Remember to order front panel, see page 43 and leg frame/middle panel, see page 50. For counter with predrilled holes for cable conduct see pages 120-121.

W	x	D
mm		
1800		800

Item no.
HPL
BI2152989003

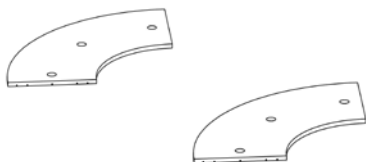

### 90° recessed curved counter - end

Remember to order front panel, see page 43 and leg frame/middle panel, see page 50. For counter with predrilled holes for cable conduct see pages 120-121.

H	x	W	x	D
mm				
740		2220		800
1000		2220		800

Item no.
HPL
BI2153929003
BI2153949003

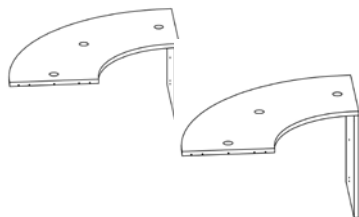

# RECESSED COUNTER

## FREESTANDING 90° CURVED COUNTERS AND FRONT PANELS

The design of Inform's recessed front panel allows for easy access on both sides of the counter and is especially suited for wheelchair use, as the front panel is placed 300 mm from the front. Remember to order front panel.

### 90° recessed curved counter - freestanding

Remember to order front panel. For counter with predrilled holes for cable conduct see pages 120-121.

H	x	W	x	D
mm				
740		2250		800
1000		2250		800

Item no.
HPL
BI2154929003
BI2154949003

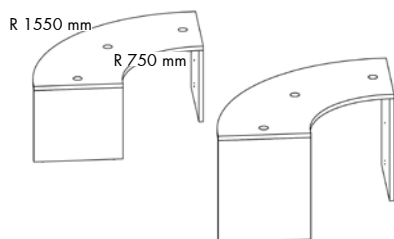

### Wooden front panel for 90° recessed curved counter

H	x	W
mm		
740		1768
1000		1768

Item no.
HPL
BI3209043
BI3209063

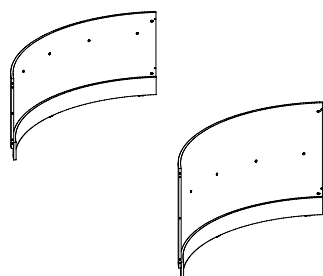

### Acrylic front panel for 90° recessed curved counter

Melaminecoated wooden frame.

H	x	W
mm		
740		1768
1000		1768

Item no.
Acrylic & melamine
BI3309046
BI3309066

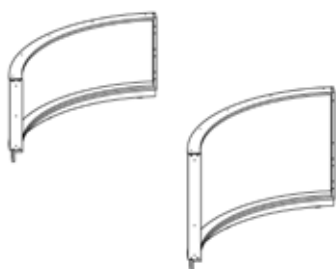

# RECESSED COUNTER

## RECTANGULAR COUNTERS - FOR CONNECTING TO STANDARD COUNTERS

The design of Inform's recessed front panel allows for easy access on both sides of the counter and is especially suited for wheelchair use, as the front panel is placed 300 mm from the front. It is available in two heights; 740 and 1000 mm. This model can be combined with standard counters of the same height by connecting with a middle panel (as the counter top is 40 mm wider than the recessed rectangular counter).

### Recessed rectangular counter - starter - connected with middle panel

Remember to order front panel, see page 45 and middle panel, see page 50. For counter with predrilled holes for cable conduct see pages 120-121.

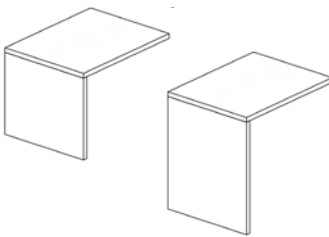

H	x	W	x	D
mm				
740	680	800		
740	880	800		
740	1080	800		
740	1280	800		
740	1480	800		
740	1680	800		
1000	680	800		
1000	880	800		
1000	1080	800		
1000	1280	800		
1000	1480	800		
1000	1680	800		

Item no.
HPL
BI2121016003
BI2121018003
BI2121020003
BI2121022003
BI2121024003
BI2121026003
BI2121036003
BI2121038003
BI2121040003
BI2121042003
BI2121044003
BI2121046003

### Recessed rectangular counter - middle - connected with middle panel

Remember to order front panel, see page 45 and middle panel, see page 50. For counter with predrilled holes for cable conduct see pages 120-121.

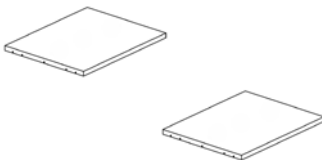

W	x	D
mm		
640	800	
840	800	
1040	800	
1240	800	
1440	800	
1640	800	

Item no.
HPL
BI2122060003
BI2122080003
BI2122081003
BI2122082003
BI2122084003
BI2122086003

### Recessed rectangular counter - end - connected with middle panel

Remember to order front panel, see page 45 and middle panel, see page 50. For counter with predrilled holes for cable conduct see pages 120-121.

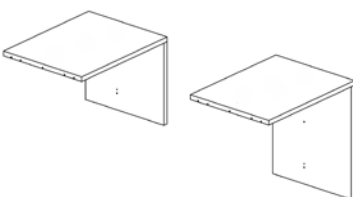

H	x	W	x	D
mm				
740	680	800		
740	880	800		
740	1080	800		
740	1280	800		
740	1480	800		
740	1680	800		
1000	680	800		
1000	880	800		
1000	1080	800		
1000	1280	800		
1000	1480	800		
1000	1680	800		

Item no.
HPL
BI2123016003
BI2123018003
BI2123020003
BI2123022003
BI2123024003
BI2123026003
BI2123036003
BI2123038003
BI2123040003
BI2123042003
BI2123044003
BI2123046003

# RECESSED COUNTER

## RECTANGULAR FRONT PANELS

Remember to order front panel.

### Wooden front panel for recessed rectangular counter

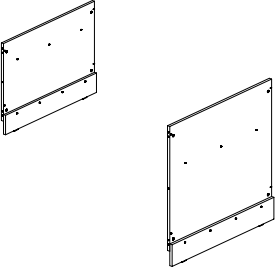
	H x W mm	Item no.	Item no.
		Melamine	Veneer
	740 600	BI300146	BI300142
	740 800	BI300346	BI300342
	740 1000	BI300446	BI300442
	740 1200	BI300546	BI300542
	740 1400	BI300646	BI300642
	740 1600	BI300746	BI300742
	1000 600	BI300166	BI300162
	1000 800	BI300366	BI300362
	1000 1000	BI300466	BI300462
	1000 1200	BI300566	BI300562
	1000 1400	BI300666	BI300662
	1000 1600	BI300766	BI300762

### Acrylic front panel for recessed rectangular counter

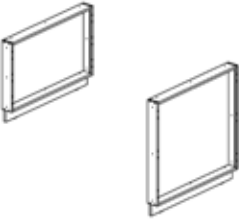
Melaminecoated wooden frame.	H x W mm	Item no.
		Acrylic & melamine
	740 600	BI310146
	740 800	BI310346
	740 1000	BI310446
	740 1200	BI310546
	740 1400	BI310646
	740 1600	BI310746
	1000 600	BI310166
	1000 800	BI310366
	1000 1000	BI310466
	1000 1200	BI310566
	1000 1400	BI310666
	1000 1600	BI310766

# RECESSED COUNTER

## 45° CURVED COUNTERS - FOR CONNECTING TO STANDARD COUNTERS

The design of Inform's recessed front panel allows for easy access on both sides of the counter and is especially suited for wheelchair use, as the front panel is placed 300 mm from the front. It is available in two heights; 740 and 1000 mm. This model can be combined with standard counters of the same height by connecting with a middle panel (as the counter top is 40 mm wider than the recessed 45° curved counter).

### 45° recessed curved counter - starter - connected with middle panel

Remember to order front panel, see page 47 and middle panel, see page 50. For counter with predrilled holes for cable conduct see pages 120-121.

H	x	W	x	D
mm				
740		2030		800
1000		2030		800

Item no.
HPL
BI2161429003
BI2161449003

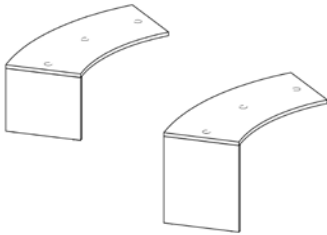

### 45° recessed curved counter - end - connected with middle panel

Remember to order front panel, see page 47 and middle panel, see page 50. For counter with predrilled holes for cable conduct see pages 120-121.

H	x	W	x	D
mm				
740		2030		800
1000		2030		800

Item no.
HPL
BI2163429003
BI2163449003

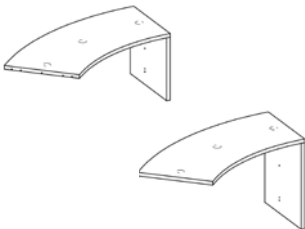

# RECESSED COUNTER

## 45° CURVED FRONT PANELS

Remember to order front panel.

---

### Wooden front panel for 45° recessed curved counter

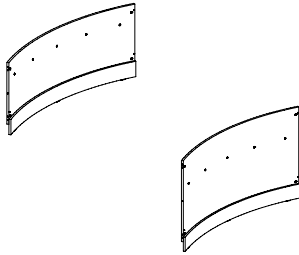

H	x	W
mm		
740		1760
1000		1760

Item no.
HPL
BI3204543
BI3204563

---

### Acrylic front panel for 45° recessed curved counter

Melaminecoated wooden frame.

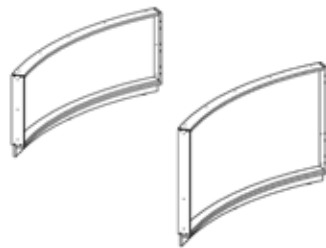

H	x	W
mm		
740		1760
1000		1760

Item no.
Acrylic & melamine
BI3304546
BI3304566

# RECESSED COUNTER

## 90° CURVED COUNTERS - FOR CONNECTING TO STANDARD COUNTERS

The design of Inform's recessed front panel allows for easy access on both sides of the counter and is especially suited for wheelchair use, as the front panel is placed 300 mm from the front. It is available in two heights; 740 and 1000 mm. This model can be combined with standard counters of the same height by connecting with a middle panel (as the counter top is 40 mm wider than the recessed 90° curved counter).

### 90° recessed curved counter - starter - connected with middle panel

Remember to order front panel, see page 49 and middle panel, see page 50. For counter with predrilled holes for cable conduct see pages 120-121.

H	x	W	x	D
mm				
740		2220		800
1000		2220		800

Item no.
HPL
BI2161929003
BI2161949003

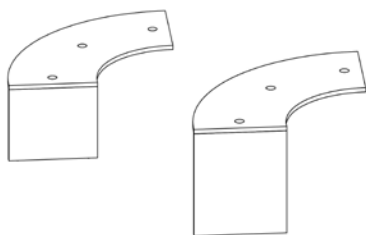

### 90° recessed curved counter - end - connected with middle panel

Remember to order front panel, see page 49 and middle panel, see page 50. For counter with predrilled holes for cable conduct see pages 120-121.

H	x	W	x	D
mm				
740		2220		800
1000		2220		800

Item no.
HPL
BI2163929003
BI2163949003

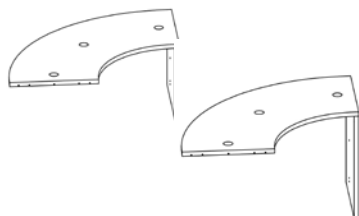



# RECESSED COUNTER

## 90° CURVED FRONT PANELS

Remember to order front panel.

---

### Wooden front panel for 90° recessed curved counter

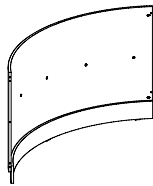
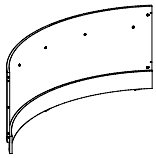

H x W  
mm

740 1768

1000 1768

Item no.  
HPL

BI3209043

BI3209063

---

### Acrylic front panel for 90° recessed curved counter

Melaminecoated wooden frame.

H x W  
mm

740 1768

1000 1768

Item no.  
Acrylic & melamine

BI3309046

BI3309066

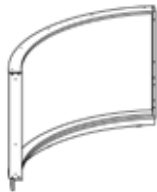

# RECESSED COUNTERS

## CONNECTIONS

If you wish to combine a recessed rectangular/curved counter with a recessed rectangular/curved counter of the same height, you must use a steel leg frame.

If you wish to combine a recessed rectangular/curved counter with standard rectangular/curved or step counter, you must use a middle panel.

### Steel leg frame for recessed counters

Must be used when assembling 2 recessed modules of the same height.

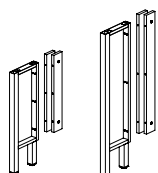

Finish	H mm	Item no. Melamine/veneer
Melamine	740	BI069546
	1000	BI069566
Veneer	740	BI069542
	1000	BI069562

### Middle panel for recessed and standard counters

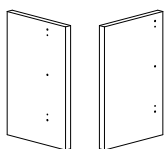

Side of panel	H mm	Item no. HPL
Left : Recessed counter Right: Standard counter	740	BI3704103

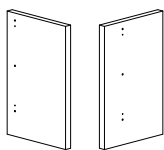

Left: Standard counter Right: Recessed counter	740	BI3704113
---	-----	-----------

### Middle panel for recessed and step counter

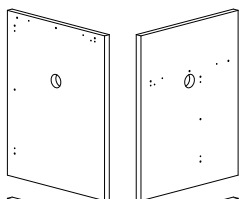

Side of panel	H mm	Item no. HPL
Left: Step counter Right: Recessed counter	1000	BI3706143

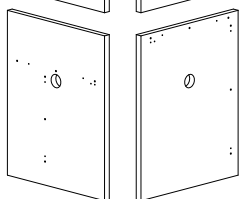

Left: Recessed counter Right: Step counter	1000	BI3706153
---	------	-----------

### Middle panel for height adjustable and recessed counter

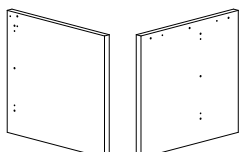

Side of panel	H mm	Item no. HPL
Left: Height adjustable counter Right: Recessed counter	740	BI3704163

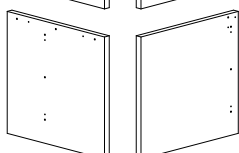

Left: Recessed counter Right: Height adjustable counter	740	BI3704173
--	-----	-----------

# RECESSED COUNTERS

## CONFIGURATIONS

If you wish to combine a recessed counter with standard rectangular/curved, height adjustable or step counter, you must use one of the panels on page 50. Remember always to construct your counter from left to right when sitting behind the counter.

---

### Rectangular counters with 2 standard fronts and 1 recessed front

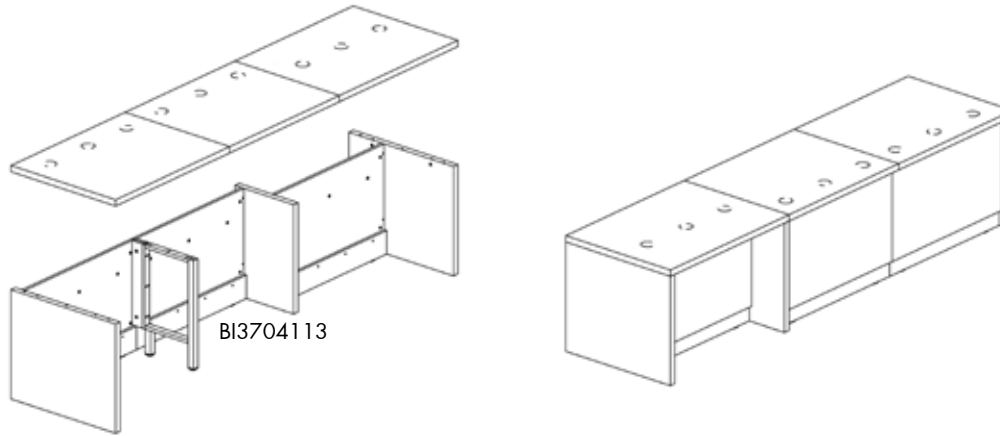

---

### Recessed and step counters

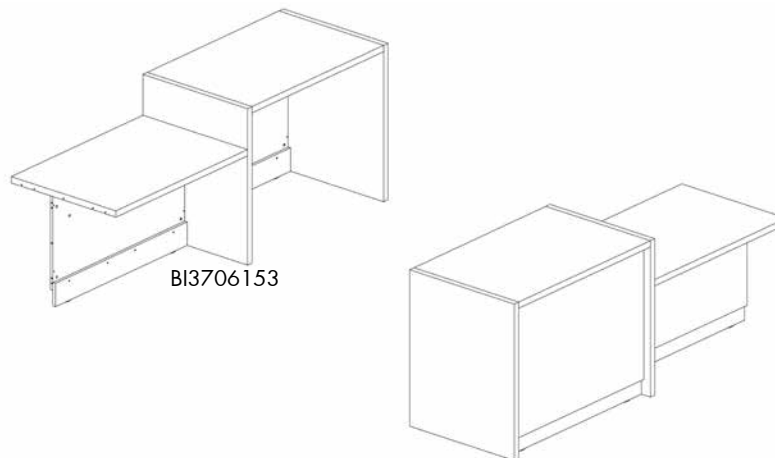

---

### Recessed rectangular and height adjustable counter

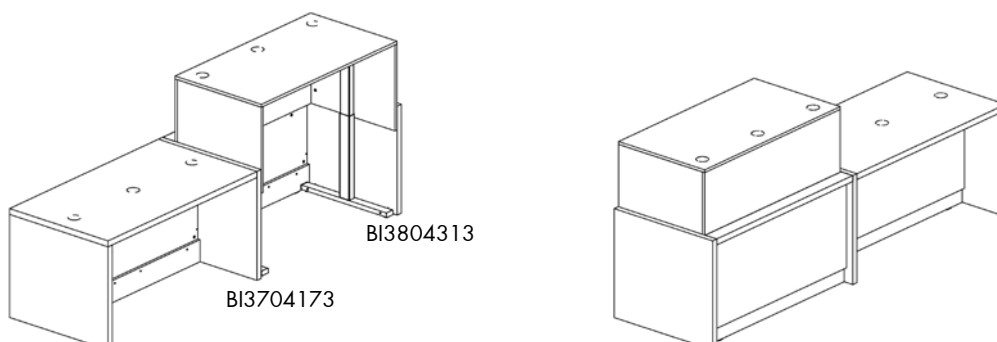

# STEP COUNTER

CONFIGURATION NO. 5

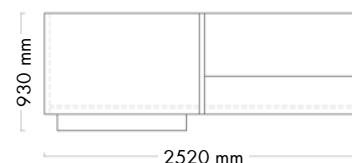

## Rectangular & step counters (with counter shelf and bag shelf)

Components	Article no.	Quantity		
Rectangular counter - starter (W1240 x H740 mm)	BI2001022003	-	1	-
Wooden front panel for rectangular counter (W1200 x H740 mm)	BI300546	-	1	-
Counter shelf and front for rectangular counter - starter (W1240 mm)	BI4101056	-	1	-
Middle panel for step and standard counter (H1000 mm)	BI3706133	-	1	-
Rectangular counter - end (W1240 x H1000 mm)	BI2003042003	-	1	-
Wooden front panel for rectangular counter (W1200 x H1000 mm)	BI300566	-	1	-
Wooden bag shelf for rectangular counter (W1200 mm)	BI81053	-	1	-
<b>Total price for configuration</b>				-

### Comments to configuration

- Monitor, office chair and text are not included in price.
- All prices are based on colours and surfaces in price group A, see pages 4-7 for colours.
- We recommend the use of desk grommets, cable rails and drawer pedestals with the Inform counter, see page 113.
- The bag shelf is in fact 1000 mm long, adapted to a 1200 mm front panel.

# STEP COUNTER

CONFIGURATION NO. 6

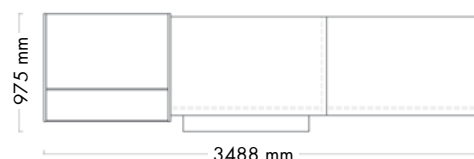

## Rectangular & step counters with presentation cabinet (with bag shelf)

Components	Article no.	Quantity		
Rectangular counter - starter (W1240 x H740 mm)	BI2001022003	-	1	-
Wooden front panel for rectangular counter (W1200 x H740 mm)	BI300546	-	1	-
Middle panel for step and standard counter (H1000 mm)	BI3706133	-	1	-
Rectangular counter - middle (W1200 x H1000 mm)	BI2002082003	-	1	-
Wooden front panel for rectangular counter (W1200 x H1000 mm)	BI300566	-	1	-
Display cabinet with 2 shelves & shelving options (W1008 x H1130 mm)	BI525127006	-	1	-
Steel intermediate shelf with backedge (W1000 x D300 mm)	B401803131	-	4	-
Wooden bag shelf for rectangular counter (W1200 mm)	BI81053	-	1	-
<b>Total price for configuration</b>				-

### Comments to configuration

- Monitor, office chair and text are not included in price.
- All prices are based on colours and surfaces in price group A, see pages 4-7 for colours.
- We recommend the use of desk grommets, cable rails and drawer pedestals with the Inform counter, see page 113.
- The bag shelf is in fact 1000 mm long, adapted to a 1200 mm front panel.
- Shelves are not included in presentation cabinet. For full overview of shelving options for presentation cabinet, see page 101.

# STEP COUNTER

## COUNTER TOPS

Vary the height of the Inform counter by adding a simple module - a step counter top. The counter top can be used for the two heights; 740 and 1000 mm. To combine with standard and recessed counters, see page 57.

---

### Step counter top

Remember to order middle panels. For counter with predrilled holes for cable conduct see pages 120-121.



H	x	W	x	D	Item no.
				mm	HPL
740		600		800	BI2002060003
740		800		800	BI2002080003
740		1000		800	BI2002081003
740		1200		800	BI2002082003
740		1400		800	BI2002084003
740		1600		800	BI2002086003

---

### Steel leg frame

Must be used when assembling 2 modules of the same height.

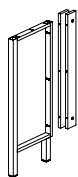

H	Item no.	Item no.
mm	Melamine	Veneer
1000	BI069166	BI069162

# STEP COUNTER

## FRONT PANELS

Vary the height of the Inform counter by adding a simple module - a step counter top. The counter top can be used for the two heights; 740 and 1000 mm. To combine with standard and recessed counters, see page 57.

### Wooden front panel for step counter

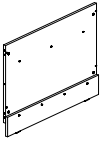
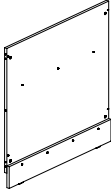
	H x W mm	Item no. Melamine	Item no. Veneer
	740 600	BI300146	BI300142
	740 800	BI300346	BI300342
	740 1000	BI300446	BI300442
	740 1200	BI300546	BI300542
	740 1400	BI300646	BI300642
	740 1600	BI300746	BI300742
		1000 600	BI300166
1000 800		BI300366	BI300362
1000 1000		BI300466	BI300462
1000 1200		BI300566	BI300562
1000 1400		BI300666	BI300662
1000 1600		BI300766	BI300762

### Acrylic front panel for step counter

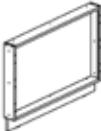
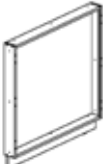
Melaminecoated wooden frame.	H x W mm	Item no. Acrylic & melamine
	74 600	BI310146
	740 800	BI310346
	740 1000	BI310446
	740 1200	BI310546
	740 1400	BI310646
	740 1600	BI310746
		1000 600
1000 800		BI310366
1000 1000		BI310466
1000 1200		BI310566
1000 1400		BI310666
1000 1600		BI310766

# STEP COUNTER

## MIDDLE PANELS

It is necessary to order side and middle panels for the step counter, depending on the construction of your complete counter. See overview of panels below. Remember always to construct your counter from left to right when sitting behind the counter!

### Middle panel for step and standard counter

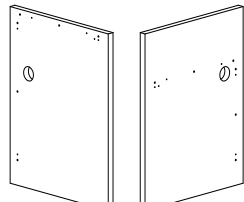
	Side of panel	H mm	Item no. HPL
	Left: Step counter Right: Standard counter (H740 mm)	1000	BI3706123
	Left: Standard counter (H740 mm) Right: Step counter	1000	BI3706133

### Middle panel for step and recessed counter

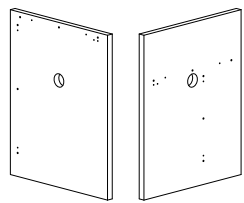
	Side of panel	H mm	Item no. HPL
	Left: Step counter Right: Recessed counter	1000	BI3706143
	Left: Recessed counter Right: Step counter	1000	BI3706153



# STEP COUNTER

## CONFIGURATIONS

The counter can be installed using either the middle panel or leg frame, depending on whether the counter is placed next to another standard counter or display cabinet. See overview of middle panels on page 56. Remember always to construct your counter from left to right when sitting behind the counter!

---

### Standard and step counter

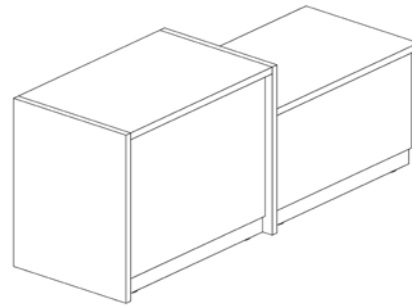
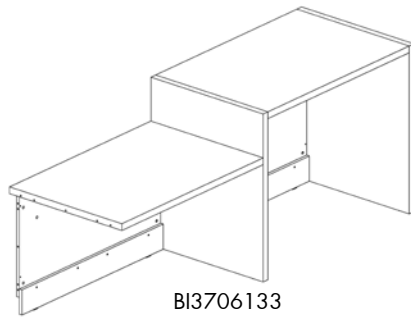

---

### Step, recessed and height adjustable counter

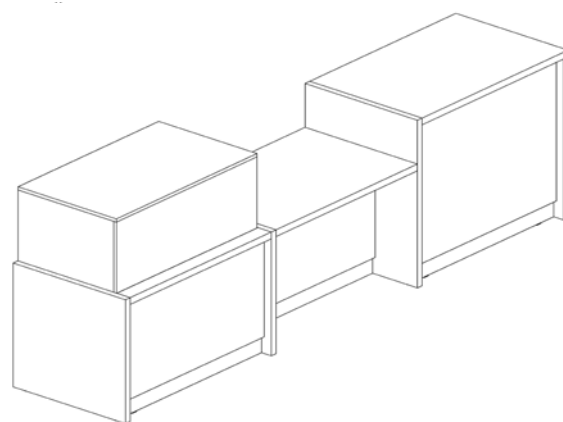
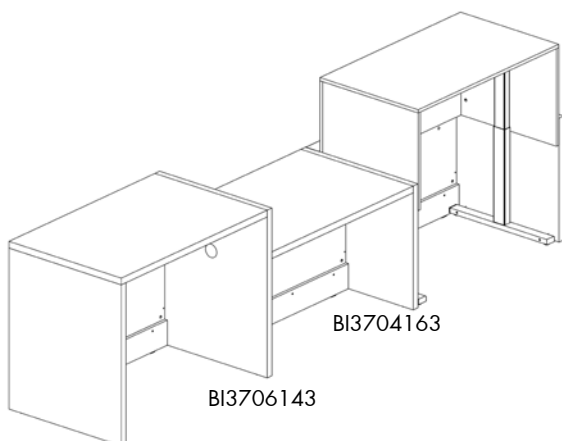

# CORNER COUNTER

CONFIGURATION NO. 11

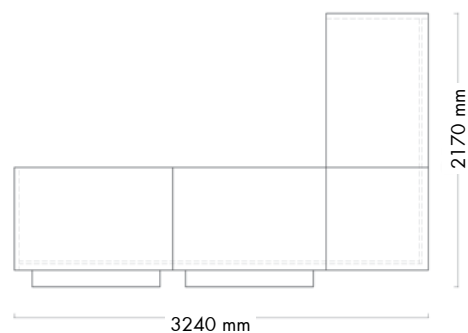

## Rectangular & square corner counters (with bag shelves)

Components	Article no.	Quantity		
Rectangular counter - starter (W1240 x H740 mm)	BI2001022003	-	1	-
Rectangular counter - middle (W1200 x H740 mm)	BI2002082003	-	1	-
Rectangular counter - end (W1240 x H740 mm)	BI2003022003	-	1	-
Square corner counter top (H740 mm)	BI26530003	-	1	-
Wooden front panel for rectangular counter (W1200 x H740 mm)	BI300546	-	3	-
Wooden front panel for square corner counter (H740 mm)	BI340346	-	1	-
Wooden bag shelf for rectangular counter (W1200 mm)	BI81053	-	2	-
Steel leg frame (H740 mm)	BI069146	-	3	-
Monitor arm	B401184	-	1	-
<b>Total price for configuration</b>				-

### Comments to configuration

- Monitor, key board, office chairs and text are not included in price.
- All prices are based on colours and surfaces in price group A, see pages 4-7 for colours.
- We recommend the use of desk grommets, cable rails and drawer pedestals with the Inform counter, see page 113.
- The bag shelf is in fact 1000 mm long, adapted to a 1200 mm front panel.
- It is necessary to drill an Ø80 mm hole for the monitor arm on site or modify the article number for counter for predrilled hole, see pages 120-121.

# CORNER COUNTER

CONFIGURATION NO. 12

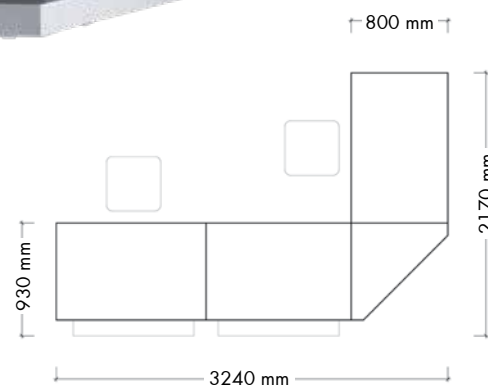

## Rectangular & triangular corner counters (with bag shelves)

Components	Article no.	Quantity		
Rectangular counter - starter (W1240 x H740 mm)	BI2001022003	-	1	-
Rectangular counter - middle (W1200 x H740 mm)	BI2002082003	-	1	-
Rectangular counter - end (W1240 x H740 mm)	BI2003022003	-	1	-
Wooden front panel for rectangular counter (W1200 x H740 mm)	BI300546	-	3	-
Triangular corner counter top (H740 mm)	BI26833003	-	1	-
Wooden front panel for triangular corner counter (H740 mm)	BI345346	-	1	-
Wooden bag shelf for rectangular counter (W1200 mm)	BI81053	-	2	-
Steel leg frame (H740 mm)	BI069146	-	3	-
<b>Total price for configuration</b>				-

### Comments to configuration

- Monitor, office chair and text are not included in price.
- All prices are based on colours and surfaces in price group A, see pages 4-7 for colours.
- We recommend the use of desk grommets, cable rails and drawer pedestals with the Inform counter, see page 113.
- The bag shelf is in fact 1000 mm long, adapted to a 1200 mm front panel.

# CORNER COUNTER

## SQUARE CORNER COUNTER TOPS, FRONT PANELS AND LEG FRAME

The corner counter is ideal for combining with the rectangular counter and the info table. The corner counter creates a sharp angle with no optical interruptions, maintaining the design of a continuous frame.

### Square corner counter top

Remember to order leg frame and front panel. For counter with predrilled holes for cable conduct see pages 120-121.

W	x	D
mm		
800		800

Item no.
HPL
BI26530003



### Wooden front panel for square corner counter

Remember to order leg frame.

H	x	W	x	D
mm				
740		800		800
1000		800		800

Item no.
Melamine
BI340346
BI340366

Item no.
Veneer
BI340342
BI340362

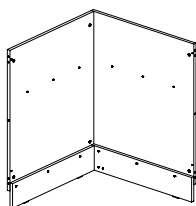
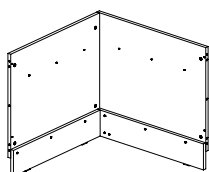

### Steel leg frame

Must be used when assembling 2 modules of the same height.

H
mm
740
1000

Item no.
Melamine
BI069146
BI069166

Item no.
Veneer
BI069142
BI069162

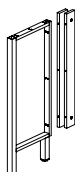
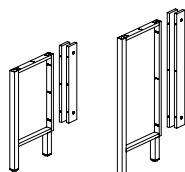

# CORNER COUNTER

## TRIANGULAR CORNER COUNTER TOPS, FRONT PANELS AND LEG FRAME

The triangular corner counter can be used for combining many of the other Inform counters. Create an open, informal look with the triangular corner counter and make a contrast to the linear lines usually found in a library.

### Triangular corner counter top

Remember to order leg frame and front panel. For counter with predrilled holes for cable conduct see pages 120-121.

W	x	D
mm		
800		800

Item no.
HPL
BI26833003

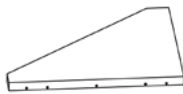

### Wooden front panel for triangular corner counter

Remember to order leg frame.

H	x	W	x	D
mm				
740		800		800
1000		800		800

Item no.
Melamine
BI345346
BI345366

Item no.
Veneer
BI345342
BI345362

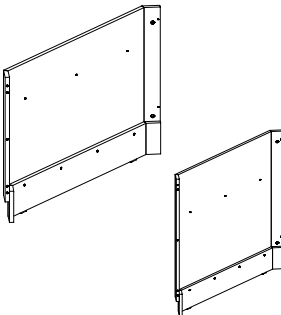

### Steel leg frame

Must be used when assembling 2 modules of the same height.

H
mm
740
1000

Item no.
Melamine
BI069146
BI069166

Item no.
Veneer
BI069142
BI069162

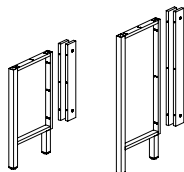

# INFO TABLE

CONFIGURATION NO. 13



## 45° & 90° curved counters & info table with foot

Components	Article no.	Quantity		
45° curved counter - starter (H740 mm)	BI2051428003	-	1	-
45° curved counter - middle (H740 mm)	BI2052488003	-	1	-
Wooden front panel for 45° curved counter (H740 mm)	BI3204543	-	2	-
90° curved counter - middle (H740 mm)	BI2052988003	-	1	-
Wooden front panel for 90° curved counter (H740 mm)	BI3209043	-	1	-
Info table - end (W800 x H740 mm)	BI27030343	-	1	-
Wooden side panel for info table (H740 mm)	BI38546	-	1	-
Steel leg frame (H740 mm)	BI069146	-	3	-
Monitor arm	B401184	-	1	-
<b>Total price for configuration</b>				-

### Comments to configuration

- Monitor, key board, office chair, chairs and text are not included in price.
- All prices are based on colours and surfaces in price group A, see pages 4-7 for colours.
- We recommend the use of desk grommets, cable rails and drawer pedestals with the Inform counter, see page 113.
- It is necessary to drill an Ø80 mm hole for the monitor arm on site or modify the article number for counter for predrilled hole, see pages 120-121.

# INFO TABLE

CONFIGURATION NO. 14

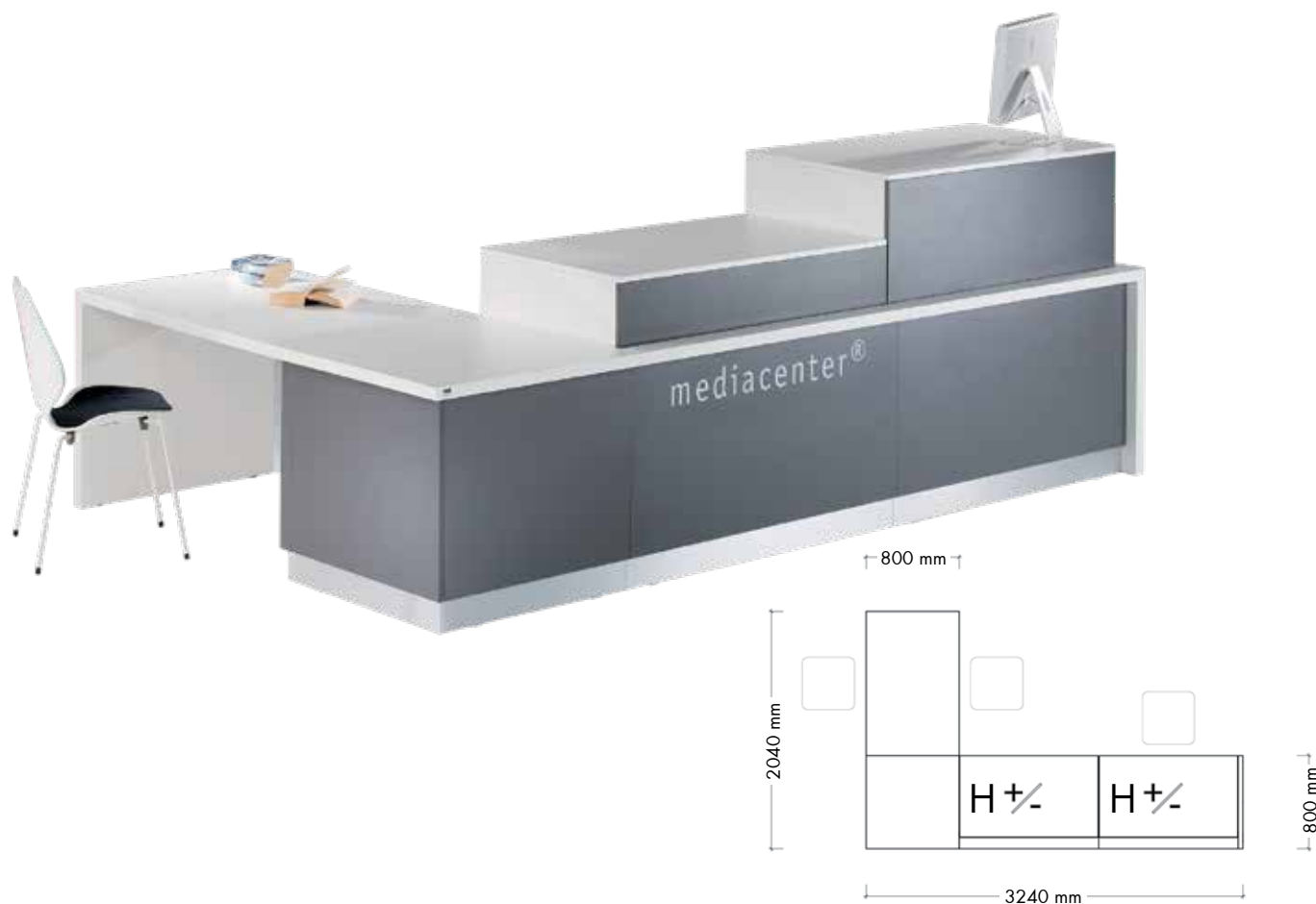

## Height adjustable counter, corner counter & info table with panel

Components	Article no.	Quantity		
Left side panel for height adjustable counter (H740 mm)	BI3804303	-	1	-
Height adjustable counter - starter, middle and end (W1200 mm)	BI24015006	-	2	-
Wooden front panel for height adjustable counter (W1200 x H740 mm)	BI350546	-	2	-
Square corner counter top for height adjustable counter on left side	BI26520003	-	1	-
Middle panel for height adjustable and standard counter (H740 mm)	BI3704193	-	1	-
Wooden front panel for square corner counter (H740 mm)	BI340346	-	1	-
Wooden side panel for info table (H740 mm)	BI38546	-	1	-
Steel leg frame for info table (H740 mm)	BI069146	-	1	-
Info table - end (H740 x W1240 mm)	BI28030543	-	1	-
<b>Total price for configuration</b>				-

### Comments to configuration

- Monitor, chair and text are not included in price.
- All prices are based on colours and surfaces in price group A, see pages 4-7 for colours.
- We recommend the use of desk grommets, cable rails and drawer pedestals with the Inform counter, see page 113.

# INFO TABLE

## COUNTER TOPS WITH FOOT, SIDE PANEL AND LEG FRAME

As an adviser, you need to portray openness and show communicative skills. This also applies for the furniture. Our info table enlarges your work area with a short table element. It provides you with an open and informal space for small discussions.

### Info table - starter

Foot included. Remember to order leg frame and wooden side panel.

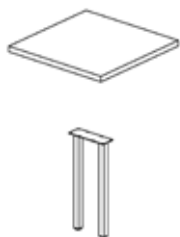

H	x	W	x	D	Item no.
mm					HPL
740		800		800	BI27010343
1000		800		800	BI27010363

### Info table - end

Foot included. Remember to order leg frame and wooden side panel.

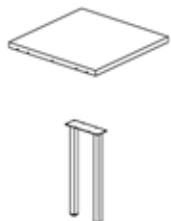

H	x	W	x	D	Item no.
mm					HPL
740		800		800	BI27030343
1000		800		800	BI27030363

### Steel leg frame

Must be used when assembling 2 modules of the same height.

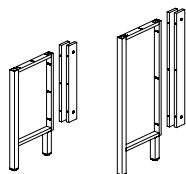

H	Item no.	Item no.
mm	Melamine	Veneer
740	BI069146	BI069142
1000	BI069166	BI069162

### Wooden side panel for info table

Used to create a finish on adjacent counter. Wooden side panel to be placed at the end of adjacent counter, with leg frame inside.

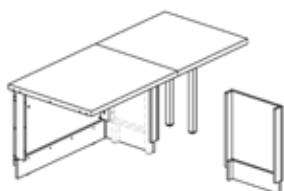

H	x	W	x	D	Item no.	Item no.
mm					Melamine	Veneer
740		800		510	BI38546	BI38542
1000		800		510	BI38566	BI38562



# INFO TABLE

## COUNTER TOPS WITH PANEL, FRONT PANELS AND LEG FRAME

As an adviser, you need to portray openness and show communicative skills. This also applies for the furniture. Our info table enlarges your work area with a short table element. It provides you with an open and informal space for small discussions.

### Info table - starter

Remember to order leg frame and wooden side panel for inside of adjacent counter.

H	x	W	x	D
mm				
740		840		800
740		1040		800
740		1240		800

Item no.
HPL
BI28010343
BI28010443
BI28010543

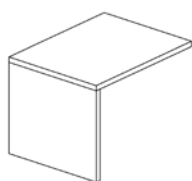

### Info table - end

Remember to order leg frame and wooden side panel for inside of adjacent counter.

H	x	W	x	D
mm				
740		840		800
740		1040		800
740		1240		800

Item no.
HPL
BI28030343
BI28030443
BI28030543

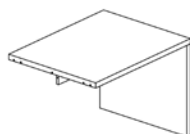

### Steel leg frame for info table

Must be used when assembling 2 modules of the same height.

H	Item no.
mm	Melamine
740	BI069146

Item no.
Veneer
BI069142

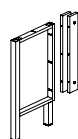

### Wooden side panel for info table

Used to create a finish on adjacent counter. Wooden side panel to be placed at the end of adjacent counter with leg frame inside.

H	x	W	x	D	Item no.
mm					Melamine
740		80		360	BI38546

Item no.
Veneer
BI38542

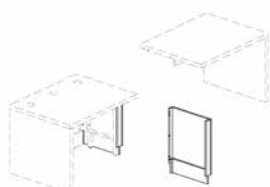

# HEIGHT ADJUSTABLE COUNTER

CONFIGURATION NO. 7

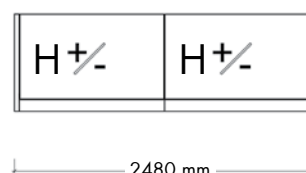

## Rectangular height adjustable counters

Components	Article no.	Quantity		
Left side panel for height adjustable counter (H740 mm)	BI3804303	-	1	-
Height adjustable counter - starter, middle and end (W1200 mm)	BI24015006	-	2	-
Wooden front panel for height adjustable counter (W1200 x H740 mm)	BI350546	-	2	-
Right side panel for height adjustable counter (H740 mm)	BI3804313	-	1	-

### Comments to configuration

- Monitor and text are not included in price.
- All prices are based on colours and surfaces in price group A, see pages 4-7 for colours.
- We recommend the use of desk grommets, cable rails and drawer pedestals with the Inform counter, see page 113.

# HEIGHT ADJUSTABLE COUNTER

CONFIGURATION NO. 8



Note: the front is flat

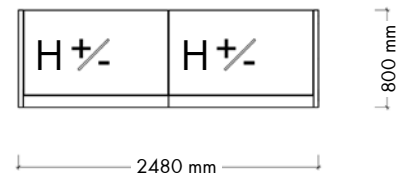

## Rectangular height adjustable counters (with acrylic front)

Components	Article no.	Quantity		
Left side panel for height adjustable counter (H740 mm)	BI3804303	-	1	-
Height adjustable counter - starter, middle and end (W1200 mm)	BI24015006	-	2	-
Acrylic front panel for height adjustable counter (W1200 x H740 mm)	BI360543	-	2	-
Right side panel for height adjustable counter (H740 mm)	BI3804313	-	1	-

### Comments to configuration

- Text is not included in price.
- All prices are based on colours and surfaces in price group A, see pages 4-7 for colours.
- We recommend the use of desk grommets, cable rails and drawer pedestals with the Inform counter, see page 113.

# HEIGHT ADJUSTABLE COUNTER

CONFIGURATION NO. 9

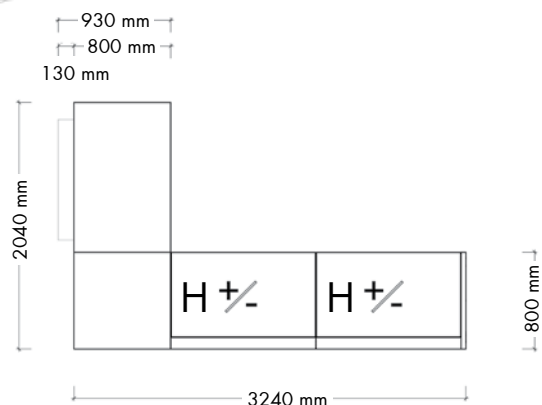

Rectangular height adjustable, corner and rectangular counters (with bag shelf)

Components	Article no.	Quantity		
Left side panel for height adjustable counter (H740 mm)	BI3804303	-	1	-
Height adjustable counter - starter, middle and end (W1200 mm)	BI24015006	-	2	-
Wooden front panel for height adjustable counter (W1200 x H740 mm)	BI350546	-	2	-
Square corner counter top for height adjustable counter on left side	BI26520003	-	1	-
Middle panel for height adjustable and standard counter (H740 mm)	BI3704193	-	1	-
Wooden front panel for square corner counter (H740 mm)	BI340346	-	1	-
Rectangular counter - end (W1240 x H740 mm)	BI2003022003	-	1	-
Wooden front panel for rectangular counter (W1200 x H740 mm)	BI300546	-	1	-
Wooden bag shelf for rectangular counter (W1200 mm)	BI81053	-	1	-

## Comments to configuration

- Monitor, office chairs and text are not included in price.
- All prices are based on colours and surfaces in price group A, see pages 4-7 for colours.
- We recommend the use of desk grommets, cable rails and drawer pedestals with the Inform counter, see page 113.
- The bag shelf is in fact 1000 mm long, adapted to a 1200 mm front panel.

# HEIGHT ADJUSTABLE COUNTER

CONFIGURATION NO. 10

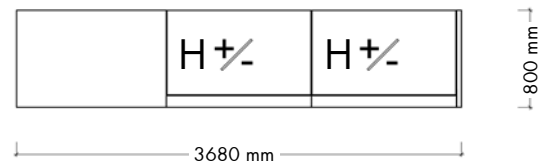

## Rectangular height adjustable and rectangular counters (with bag shelves)

Components	Article no.	Quantity		
Left side panel for height adjustable counter (H740 mm)	BI3804303	-	1	-
Height adjustable counter - starter, middle and end (W1200 mm)	BI24015006	-	2	-
Wooden front panel for height adjustable counter (W1200 x H740 mm)	BI350546	-	2	-
Middle panel for height adjustable and standard counter (H740 mm)	BI3704193	-	1	-
Rectangular counter for height adj. counter - end (W1240 x H740 mm)	BI2305022003	-	1	-
Wooden front panel for rectangular counter (W1200 x H740 mm)	BI300546	-	1	-
Wooden bag shelf for rectangular counter (W1200 mm)	BI81053	-	2	-

### Comments to configuration

- Monitor, display and text are not included in price.
- All prices are based on colours and surfaces in price group A, see pages 4-7 for colours.
- We recommend the use of desk grommets, cable rails and drawer pedestals with the Inform counter, see page 113.
- The bag shelves are in fact 1000 mm long, adapted to 1200 mm front panels.

# HEIGHT ADJUSTABLE COUNTER

## RECTANGULAR COUNTERS

The height adjustable counter is a double construction with a moveable upper part and a fixed lower part. The moveable part of the counter slides along the walls of the fixed parts excluding possible safety risks such as entrapment and bruising. With the electrical driven height adjustable counter, you can adjust your working height ranging between 680 mm and 1180 mm. To construct a complete counter including a height adjustable counter, you must use the products shown on pages 72-81.

### Height adjustable counter

Available in 3 versions:  
 (1) for European market,  
 (2) for US market 110V  
 (3) for UK market.

Side, front and middle panels to be ordered separately. For counter with predrilled holes for cable conduct see pages 120-121.

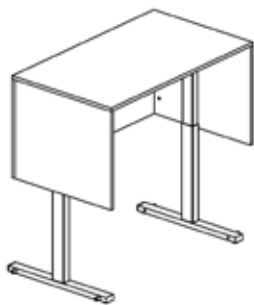

	H	x	W	x	D	Item no. Melamine	Item no. Veneer
	mm						
(1)	680-1180	1000	700			BI24014006	BI25014002
	680-1180	1200	700			BI24015006	BI25015002
	680-1180	1400	700			BI24016006	BI25016002
	680-1180	1600	700			BI24017006	BI25017002
(2)	680-1180	1000	700			BI24024006	BI25024002
	680-1180	1200	700			BI24025006	BI25025002
	680-1180	1400	700			BI24026006	BI25026002
	680-1180	1600	700			BI24027006	BI25027002
(3)	680-1180	1000	700			BI24034006	BI25034002
	680-1180	1200	700			BI24035006	BI25035002
	680-1180	1400	700			BI24036006	BI25036002
	680-1180	1600	700			BI24037006	BI25037002

### Wooden front panel for height adjustable counter

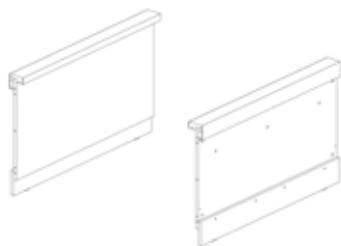

H	x	W	Item no. Melamine	Item no. Veneer
mm				
740	1000		BI350446	BI350442
740	1200		BI350546	BI350542
740	1400		BI350646	BI350642
740	1600		BI350746	BI350742

### Acrylic front panel for height adjustable counter

HPL wooden frame.



H	x	W	Item no. Acrylic & HPL
mm			
740	1000		BI360443
740	1200		BI360543
740	1400		BI360643
740	1600		BI360743

# HEIGHT ADJUSTABLE COUNTER

## FRONT AND SIDE PANELS

Remember to order front and side panels for your height adjustable counter.

---

### Side panel for height adjustable counter - for start/end

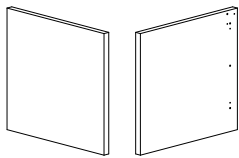
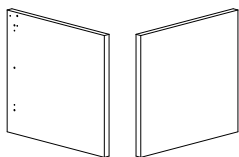
	Side	H mm	Item no. HPL
	Left: No drill holes Right: Height adjustable counter	740	BI3804303
	Left: Height adjustable counter Right: No drill holes	740	BI3804313

# HEIGHT ADJUSTABLE COUNTER

## H740 MM RECTANGULAR COUNTERS FOR HEIGHT ADJUSTABLE COUNTER

If you wish to add a rectangular H740 mm counter to Inform height adjustable counters, you must use the counters shown below. If you wish to add a rectangular H1000 mm counter, see page 22. See overview on page 82 to find the correct middle panel for your construction.

### H740 mm rectangular counter for right sided height adjustable counter - starter

Left side: Starter Right side: Height adjustable Use with middle panel BI3704193, see page 82. Remember to order front panel, see next page. For counters with predrilled holes for cable conduct, see pages 120-121.	H x W x D mm	Item no. HPL
	740 640 800	BI2301016003
	740 840 800	BI2301018003
	740 1040 800	BI2301020003
	740 1240 800	BI2301022003
	740 1440 800	BI2301024003
	740 1640 800	BI2301026003

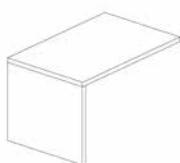

### H740 mm rectangular counter for right sided height adjustable counter - middle

Left side: Rectangular/curved/corner Right side: Height adjustable Use with middle panel BI3704193, see page 82. Remember to order front panel, see next page. For counters with predrilled holes for cable conduct, see pages 120-121.	H x W x D mm	Item no. HPL
	740 640 800	BI2302060003
	740 840 800	BI2302080003
	740 1040 800	BI2302081003
	740 1240 800	BI2302082003
	740 1440 800	BI2302084003
	740 1640 800	BI2302086003



### H740 mm rectangular counter for height adjustable counter on both sides

Left side: Height adjustable Right side: Height adjustable Use with two middle panels BI3704183 and BI3704193, see page 82. Remem- ber to order front panel, see next page. For counters with predrilled holes for cable conduct, see pages 120-121.	H x W x D mm	Item no. HPL
	740 600 800	BI2303060003
	740 800 800	BI2303080003
	740 1000 800	BI2303081003
	740 1200 800	BI2303082003
	740 1400 800	BI2303084003
	740 1600 800	BI2303086003





# HEIGHT ADJUSTABLE COUNTER

## H740 MM RECTANGULAR COUNTERS AND FRONTS FOR HEIGHT ADJUSTABLE COUNTER

If you wish to add a rectangular H740 mm counter to Inform height adjustable counters, you must use the counters shown below. If you wish to add a rectangular H1000 mm counter, see page 22. See overview on page 82 to find the correct middle panel for your construction.

### H740 mm rectangular counter for left sided height adjustable counter - middle

Left side: Height adjustable Right side: Rectangular/curved/corner Use with middle panel BI3704183, see page 82. Remember to order front panel, see below. For counters with predrilled holes for cable conduct, see pages 120-121.	H x W x D mm	Item no. HPL
	740 600 800	BI2304060003
	740 800 800	BI2304080003
	740 1000 800	BI2304081003
	740 1200 800	BI2304082003
	740 1400 800	BI2304084003
	740 1600 800	BI2304086003



### H740 mm rectangular counter for left sided height adjustable counter - end

Left side: Height adjustable Right side: End Use with middle panel BI3704183, see page 82. Remember to order front panel, see below. For counters with predrilled holes for cable conduct, see pages 120-121.	H x W x D mm	Item no. HPL
	740 640 800	BI2305016003
	740 840 800	BI2305018003
	740 1040 800	BI2305020003
	740 1240 800	BI2305022003
	740 1440 800	BI2305024003
	740 1640 800	BI2305026003



### Wooden or acrylic front panel for rectangular counter for height adjustable counter

Wooden: Melaminecoated/veneer. Acrylic: Melaminecoated wooden frame.	H x W mm	Item no. Melamine/veneer	Item no. Acrylic & melamine
	740 600	BI300146	BI310146
	740 800	BI300346	BI310346
	740 1000	BI300446	BI310446
	740 1200	BI300546	BI310546
	740 1400	BI300646	BI310646
	740 1600	BI300746	BI310746
	740 600	BI300142	
	740 800	BI300342	
	740 1000	BI300442	
	740 1200	BI300542	
	740 1400	BI300642	
	740 1600	BI300742	

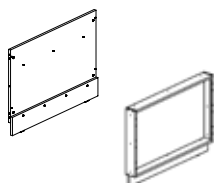

# HEIGHT ADJUSTABLE COUNTER

## H740 MM 45° CURVED COUNTERS FOR HEIGHT ADJUSTABLE COUNTER

If you wish to add a 45° curved H740 mm counter to Inform height adjustable counters, you must use the counters shown below. If you wish to add a 45° curved H1000 mm counter, see page 24. See overview on page 82 to find the correct middle panel for your construction.

---

### 45° curved counter for right sided height adjustable counter - starter

Left side: Starter	H x W x D	Item no.
Right side: Height adjustable	mm	HPL
Use with middle panel BI3704193, see page 82. Remember to order front panel, see next page. For counters with predrilled holes for cable conduct, see pages 120-121.	740 1835 800	BI2351428003

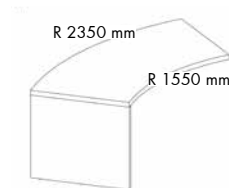

---

### 45° curved counter for right sided height adjustable counter - middle

Left side: Rectangular/curved/corner	H x W x D	Item no.
Right side: Height adjustable	mm	HPL
Use with middle panel BI3704193, see page 82. Remember to order front panel, see next page. For counters with predrilled holes for cable conduct, see pages 120-121.	740 1800 800	BI2352488003



---

### 45° curved counter for height adjustable counter on both sides

Left side: Height adjustable	H x W x D	Item no.
Right side: Height adjustable	mm	HPL
Use with two middle panels BI3704183 and BI3704193, see page 82. Remember to order front panel, see next page. For counters with predrilled holes for cable conduct, see pages 120-121.	740 1800 800	BI2353488003



# HEIGHT ADJUSTABLE COUNTER

## H740 MM 45° CURVED COUNTERS AND FRONT PANELS FOR HEIGHT ADJUSTABLE COUNTER

If you wish to add a 45° curved H740 mm counter to Inform height adjustable counters, you must use the counters shown below. If you wish to add a 45° curved H1000 mm counter, see page 24. See overview on page 82 to find the correct middle panel for your construction.

### 45° curved counter for left sided height adjustable counter - middle

Left side: Height adjustable	H x W x D	Item no.
Right side: Rectangular/curved/corner	mm	HPL
Use with middle panel BI3704183, see page 82. Remember to order front panel, see below. For counters with predrilled holes for cable conduct, see pages 120-121.	740 1800 800	BI2354488003



### 45° curved counter for left sided height adjustable counter - end

Left side: Height adjustable	H x W x D	Item no.
Right side: End	mm	HPL
Use with middle panel BI3704183, see page 82. Remember to order front panel, see below. For counters with predrilled holes for cable conduct, see pages 120-121.	740 1835 800	BI2355428003

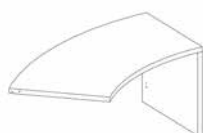

### Wooden or acrylic front panel for 45° curved counter

Wooden: High pressure laminate (HPL)	H x W	Item no.	Item no.
Acrylic: Melaminecoated wooden frame.	mm	HPL	Acrylic & melamine
	740 1760	BI3204543	BI3304546

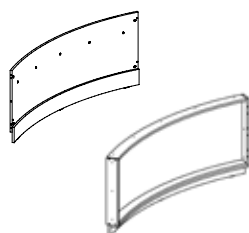

# HEIGHT ADJUSTABLE COUNTER

## H740 MM 90° CURVED COUNTERS FOR HEIGHT ADJUSTABLE COUNTER

If you wish to add a 90° curved H740 mm counter to Inform height adjustable counters, you must use the counters shown below. If you wish to add a 90° curved H1000 mm counter, see page 26. See overview on page 82 to find the correct middle panel for your construction.

---

### 90° curved counter for right sided height adjustable counter - starter

Left side: Starter	H x W x D	Item no.
Right side: Height adjustable	mm	HPL
Use with middle panel BI3704193, see page 82. Remember to order front panel, see next page. For counters with predrilled holes for cable conduct, see pages 120-121.	740 1870 800	BI2351928003

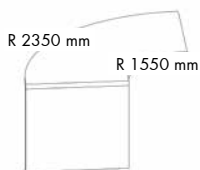

---

### 90° curved counter for right sided height adjustable counter - middle

Left side: Rectangular/curved/corner	H x W x D	Item no.
Right side: Height adjustable	mm	HPL
Use with middle panel BI3704193, see page 82. Remember to order front panel, see next page. For counters with predrilled holes for cable conduct, see pages 120-121.	740 1840 800	BI2352988003



---

### 90° curved counter for height adjustable counter on both sides

Left side: Height adjustable	H x W x D	Item no.
Right side: Height adjustable	mm	HPL
Use with two middle panels BI3704183 and BI3704193, see page 82. Remember to order front panel, see next page. For counters with predrilled holes for cable conduct, see pages 120-121.	740 1840 800	BI2353988003



# HEIGHT ADJUSTABLE COUNTER

## H740 MM 90° CURVED COUNTERS AND FRONT PANELS FOR HEIGHT ADJUSTABLE COUNTER

If you wish to add a 90° curved H740 mm counter to Inform height adjustable counters, you must use the counters shown below. If you wish to add a 90° curved H1000 mm counter, see page 26. See overview on page 82 to find the correct middle panel for your construction.

### 90° curved counter for left sided height adjustable counter - middle

Left side: Height adjustable	H x W x D	Item no.
Right side: Rectangular/curved/corner	mm	HPL
Use with middle panel BI3704183, see page 82. Remember to order front panel, see below. For counters with predrilled holes for cable conduct, see pages 120-121.	740 1840 800	BI2354988003

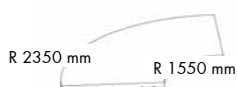

### 90° curved counter for left sided height adjustable counter - end

Left side: Height adjustable	H x W x D	Item no.
Right side: End	mm	HPL
Use with middle panel BI3704183, see page 82. Remember to order front panel, see below. For counters with predrilled holes for cable conduct, see pages 120-121.	740 1870 800	BI2355928003

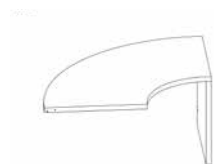

### Wooden or acrylic front panel for 90° curved counter

Wooden: High pressure laminate (HPL)	H x W	Item no.	Item no.
Acrylic: Melaminecoated wooden frame.	mm	HPL	Acrylic & melamine
	740 1768	BI3209043	BI3309066

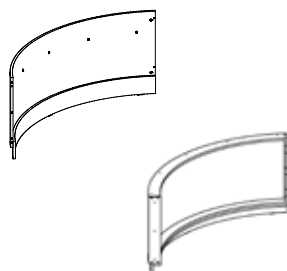

# HEIGHT ADJUSTABLE COUNTER

## H740 MM 45° CURVED COUNTERS FOR HEIGHT ADJUSTABLE AND RECESSED COUNTER

If you wish to place a 45° curved H740 mm counter in between a height adjustable counter and a recessed counter, you must use the counters shown below.

---

### 45° curved counter for right sided height adjustable counter - middle

Left side: Recessed - use with middle panel BI3704103.	H x W x D mm	Item no. HPL
Right side: Height adjustable - use with middle panel BI3704183. Remember to order front panel, see below. For counters with predrilled holes for cable conduct, see pages 120-121.	740 xx 800	BI2362488003

---

### 45° curved counter for left sided height adjustable counter - middle

Left side: Height adjustable - use with middle panel BI3704183.	H x W x D mm	Item no. HPL
Right side: Recessed - use with middle panel BI3704103. Remember to order front panel, see below. For counters with predrilled holes for cable conduct, see pages 120-121.	740 xx 800	BI2364488003

---

### Wooden or acrylic front panel for 45° curved counter

Wooden: High pressure laminate (HPL) Acrylic: Melaminecoated wooden frame.	H x W mm	Item no. HPL	Item no. Acrylic & melamine
	740 1760	BI3204543	BI3304546

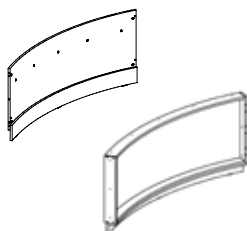

# HEIGHT ADJUSTABLE COUNTER

## H740 MM 90° CURVED COUNTERS PANELS FOR HEIGHT ADJUSTABLE AND RECESSED COUNTER

If you wish to place a 90° curved H740 mm counter in between a height adjustable counter and a recessed counter, you must use the counters shown below.

### 90° curved counter for right sided height adjustable counter - middle

Left side: Recessed - use with middle panel BI3704103.	H x W x D mm	Item no. HPL
Right side: Height adjustable - use with middle panel BI3704183. Remember to order front panel, see below. For counters with predrilled holes for cable conduct, see pages 120-121.	740 xx 800	BI2362988003

### 90° curved counter for left sided height adjustable counter - middle

Left side: Height adjustable - use with middle panel BI3704183.	H x W x D mm	Item no. HPL
Right side: Recessed - use with middle panel BI3704103. Remember to order front panel, see below. For counters with predrilled holes for cable conduct, see pages 120-121.	740 xx 800	BI2364988003

### Wooden or acrylic front panel for 90° curved counter

Wooden: High pressure laminate (HPL) Acrylic: Melaminecoated wooden frame.	H x W mm	Item no. HPL	Item no. Acrylic & melamine
	740 1768	BI3209043	BI3309066

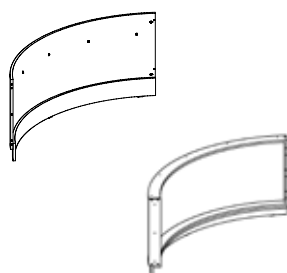

# HEIGHT ADJUSTABLE COUNTER

## SQUARE CORNER COUNTER FOR HEIGHT ADJUSTABLE COUNTER

If you wish to add a square corner counter to Inform height adjustable counters, you must use the counters shown below. See overview on page 82 to find the correct middle panel for your construction.

---

### Square corner counter top for right sided height adjustable counter

Left side: Rectangular	H x W x D	Item no.
Right side: Height adjustable	mm	HPL
Use with middle panel BI3704193, see page 82. Remember to order front panel, see below. For counters with predrilled holes for cable conduct, see pages 108- 109.	740 800 800	BI26510003



---

### Square corner counter top for left sided height adjustable counter

Left side: Height adjustable	H x W x D	Item no.
Right side: Rectangular	mm	HPL
Use with middle panel BI3704183, see page 82. Remember to order front panel, see below. For counters with predrilled holes for cable conduct, see pages 120-121.	740 800 800	BI26520003



---

### Wooden front panel for square corner counter

H x W x D	Item no.	Item no.
mm	Melamine	Veneer
740 800 800	BI340346	BI340342

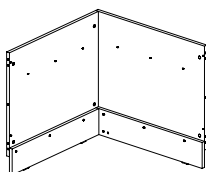



# HEIGHT ADJUSTABLE COUNTER

## TRIANGULAR CORNER COUNTER FOR HEIGHT ADJUSTABLE COUNTER

If you wish to add a triangular corner counter to Inform height adjustable counters, you must use the counters shown below. See overview on page 82 to find the correct middle panel for your construction.

---

### Triangular corner counter top for right sided height adjustable counter

Left side: Rectangular	H x W x D	Item no.
Right side: Height adjustable	mm	HPL
Use with middle panel BI3704193 (see page 82. Remember to order front panel, see below. For counters with predrilled holes for cable conduct, see pages 120-121.	740 800 800	BI26813003

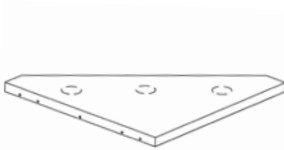

---

### Triangular corner counter top for left sided height adjustable counter

Left side: Height adjustable	H x W x D	Item no.
Right side: Rectangular	mm	HPL
Use with middle panel BI3704183, see page 82. Remember to order front panel, see below. For counters with predrilled holes for cable conduct, see pages 120-121.	740 800 800	BI26823003

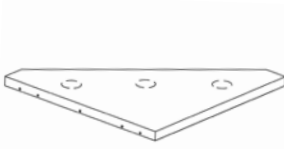

---

### Wooden front panel for triangular corner counter

Remember to order leg frame.	H x W x D	Item no.	Item no.
	mm	Melamine	Veneer
	740 800 800	BI345346	BI345342

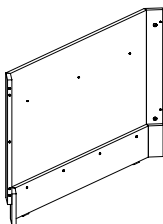

# HEIGHT ADJUSTABLE COUNTERS

## MIDDLE PANELS

It is necessary to order side and middle panels for the height adjustable counter BI240, depending on the construction of your complete counter. See overview of middle panels below. Note - do not place more than 2 height adjustable counters next to each other and remember always to construct your counter from left to right when sitting behind the counter.

### Middle panel for height adjustable and rectangular/curved/corner counters, see pages 72-79

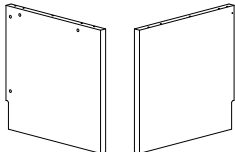
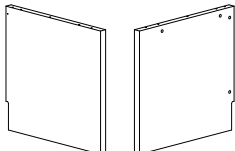
Side of panel	H mm	Item no. HPL
 <p>Left: H740 mm rectangular/curved/corner for height adjustable counter Right: Height adjustable counter</p>	740	BI3704183
 <p>Left: Height adjustable counter Right: H740 mm rectangular/curved/corner for height adjustable counter</p>	740	BI3704193

### Middle panel for height adjustable and recessed counter, see pages 38-50

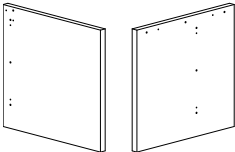
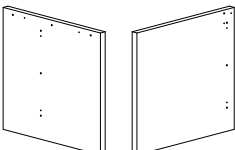
Side of panel	H mm	Item no. HPL
 <p>Left: Height adjustable counter Right: Recessed counter</p>	740	BI3704163
 <p>Left: Recessed counter Right: Height adjustable counter</p>	740	BI3704173

### Middle panel for height adjustable and step counter, see pages 54-56

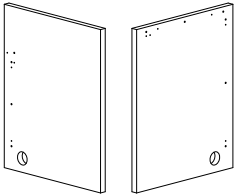
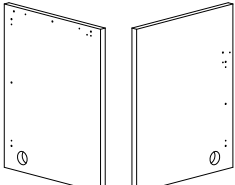
Side of panel	H mm	Item no. HPL
 <p>Left: Height adjustable counter Right: Rectangular/step counter (1000 mm)</p>	1000	BI3706203
 <p>Left: Rectangular/step counter (1000 mm) Right: Height adjustable counter</p>	1000	BI3706213

# HEIGHT ADJUSTABLE COUNTER

## CONFIGURATIONS

It is necessary to order side and middle panels for the height adjustable counter BI240, depending on the construction of your complete counter. See overview of middle panels on page 82. Note - do not place more than 2 height adjustable counters next to each other and remember always to construct your counter from left to right when sitting behind the counter.

### Rectangular and height adjustable counter

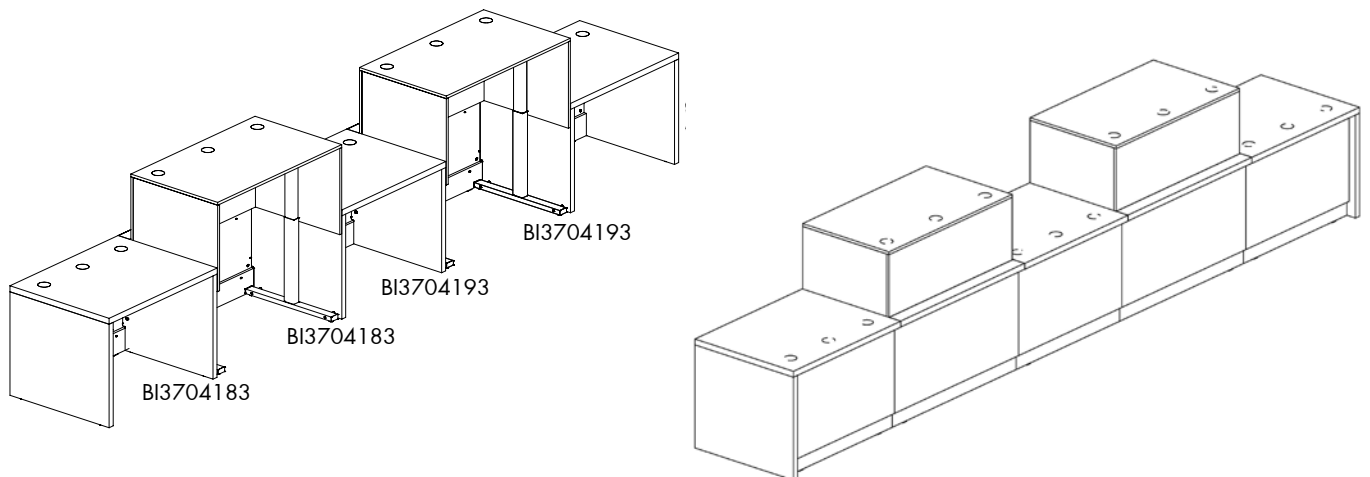

### Recessed rectangular and height adjustable counter

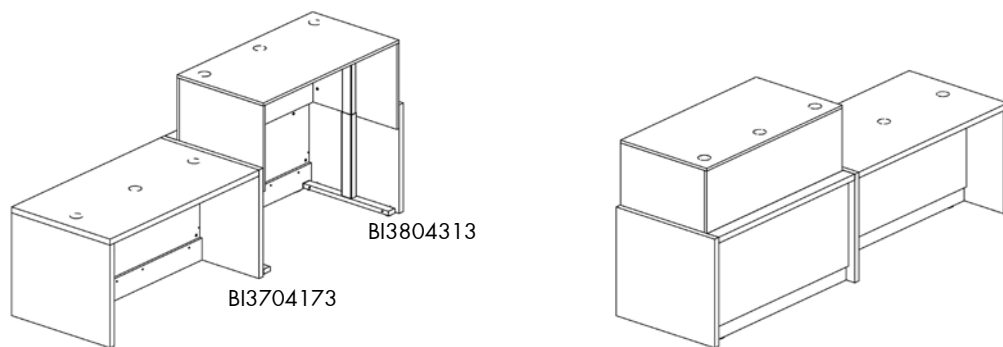

### Special rectangular, height adjustable, corner and info counters

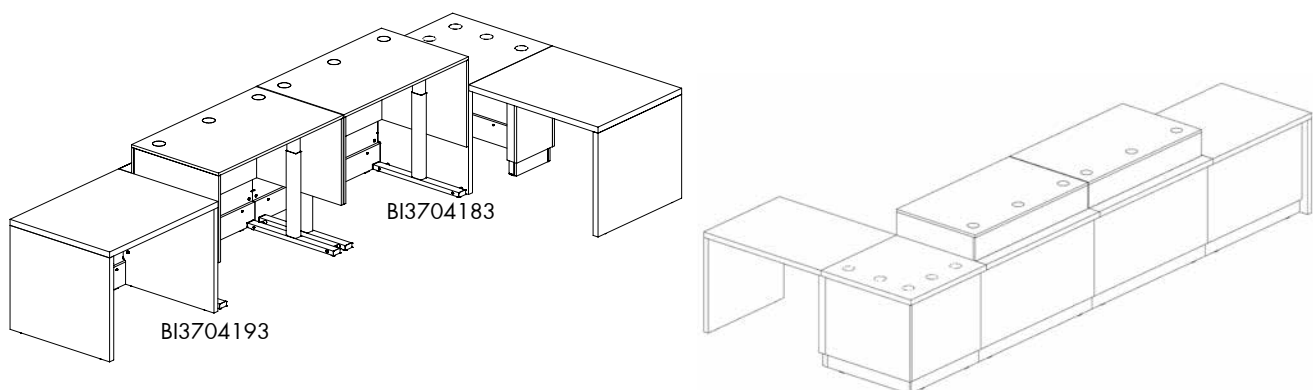

# COUNTER SHELF

## STANDARD AND SPECIAL SOLUTIONS

### COUNTER SHELVES FOR VARIOUS COUNTERS

When ordering freestanding counter shelf for your counter, please note the following:

A freestanding counter shelf has (equal to a freestanding counter) 40 mm end panels on both sides. The front of the counter shelf has the same measurement as the counter below. This means that if you place a freestanding counter shelf (with two end panels) on a counter built up of two modules, the end panel of the counter shelf will be placed on the top of the adjacent counter.

It is possible to construct a freestanding counter shelf that fits on the counters below, (see 3 options below), but this must be specially requested. Contact customer service for details.

### STANDARD

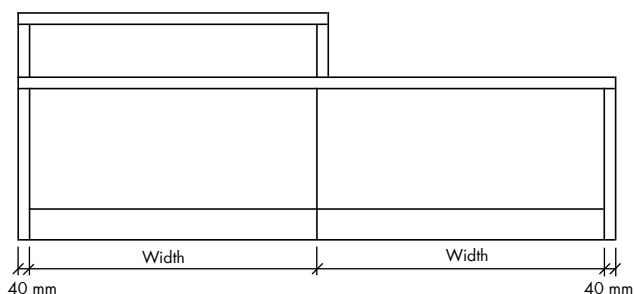

### SPECIAL SOLUTION 1

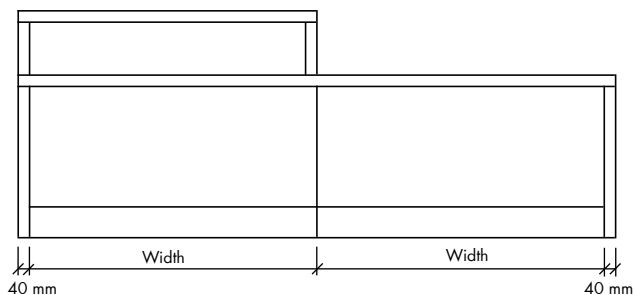

### SPECIAL SOLUTION 2

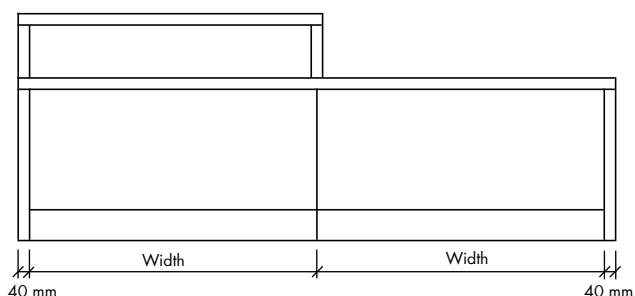

### SPECIAL SOLUTION 3

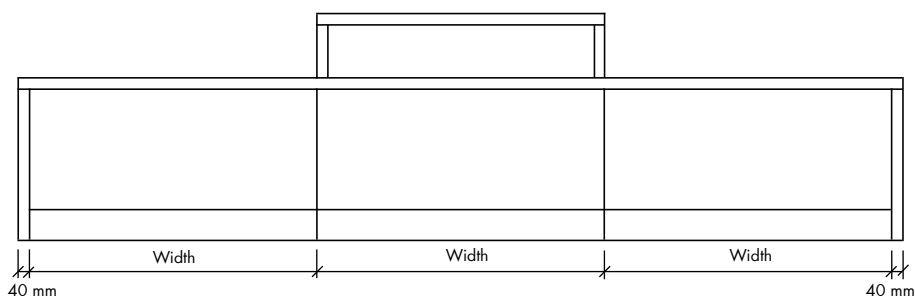

# COUNTER SHELF

CONFIGURATION NO. 15



## Rectangular & square corner counters (with counter shelves and bag shelves)

Components	Article no.	Quantity		
Rectangular counter - starter (W1240 x H740 mm)	BI2001022003	-	1	-
Rectangular counter - middle (W1200 x H740 mm)	BI2002082003	-	1	-
Rectangular counter - end (W1240 x H740 mm)	BI2003022003	-	1	-
Square corner counter top (H740 mm)	BI26530003	-	1	-
Wooden front panel for rectangular counter (W1200 x H740 mm)	BI300546	-	2	-
Acrylic front panel for rectangular counter (W1200 x H740 mm)	BI310546	-	1	-
Wooden front panel for square corner counter (H740 mm)	BI340346	-	1	-
Wooden bag shelf for rectangular counter (W1200 mm)	BI81053	-	2	-
Counter shelf and front for rectangular counter - starter (W1240 mm)	BI4101056	-	1	-
Counter shelf and front for rectangular counter - end (W1240 mm)	BI4103056	-	1	-
Steel leg frame (H740 mm)	BI069146	-	3	-

### Comments to configuration

- Office chair, monitors, Puppy and text are not included in price.
- All prices are based on colours and surfaces in price group A, see pages 4-7 for colours.
- We recommend the use of desk grommets, cable rails and drawer pedestals with the Inform counter, see page 113.
- The bag shelf is in fact 1000 mm long, adapted to a 1200 mm front panel.

# COUNTER SHELF

CONFIGURATION NO. 16

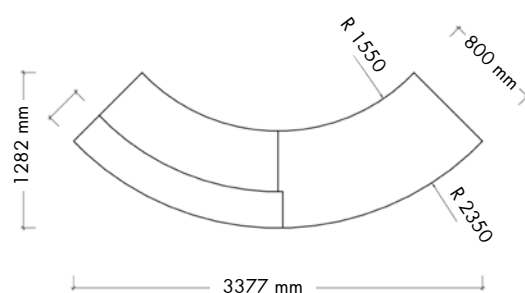

## 45° curved counters (with counter shelf)

Components	Article no.	Quantity		
45° curved counter - starter (H740 mm)	BI2051428003	-	1	-
45° curved counter - end (H740 mm)	BI2053428003	-	1	-
Wooden front panel for 45° curved counter (H740 mm)	BI3204543	-	2	-
Steel leg frame (H740 mm)	BI069146	-	1	-
Counter shelf with front panel for 45° counter - freestanding	BI431443	-	1	-

### Comments to configuration

- Monitor and text are not included in price.
- All prices are based on colours and surfaces in price group A, see pages 4-7 for colours.
- We recommend the use of desk grommets, cable rails and drawer pedestals with the Inform counter, see page 113.

# COUNTER SHELF

CONFIGURATION NO. 17

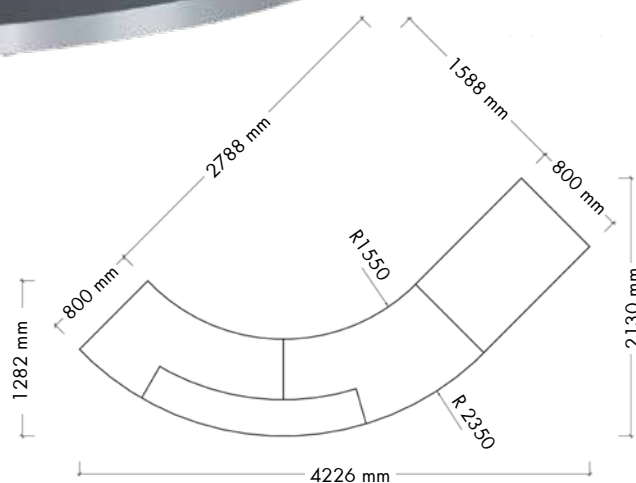

## 45° curved and rectangular counters (with counter shelf)

Components	Article no.	Quantity
Rectangular counter - starter (W1240 x H740 mm)	BI2001022003	1
45° curved counter - middle (H740 mm)	BI2052488003	1
45° curved counter - end (H740 mm)	BI2053428003	1
Wooden front panel for rectangular counter (W1200 x H740 mm)	BI300546	1
Wooden front panel for 45° curved counter (H740 mm)	BI3204543	2
Steel leg frame (H740 mm)	BI069146	2
Counter shelf with front panel for 45° counter - freestanding	BI431443	1

### Comments to configuration

- Monitor and text are not included in price.
- All prices are based on colours and surfaces in price group A, see pages 4-7 for colours.
- We recommend the use of desk grommets, cable rails and drawer pedestals with the Inform counter, see page 113.

# COUNTER SHELF

## COUNTER SHELVES FOR RECTANGULAR COUNTERS

Create a private working space by adding a counter shelf to your standard rectangular counter. It has both practical and optical advantages.

### Wooden counter shelf with front panel for rectangular counter - starter

High pressure laminate (HPL) counter shelf and melamine coated/veneer front panel.

H x W x D  
mm

Item no.  
HPL & melamine

Item no.  
HPL & veneer

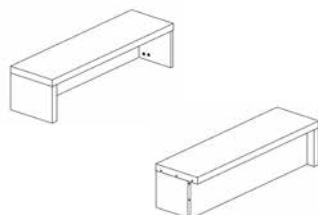

260	640	300
260	840	300
260	1040	300
260	1240	300
260	1440	300
260	1640	300

BI4101016
BI4101036
BI4101046
BI4101056
BI4101066
BI4101076

BI4151012
BI4151032
BI4151042
BI4151052
BI4151062
BI4151072

### Wooden counter shelf with front panel for rectangular counter - middle

High pressure laminate (HPL) counter shelf and melamine coated/veneer front panel.

H x W x D  
mm

Item no.  
HPL & melamine

Item no.  
HPL & veneer

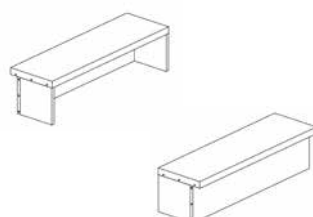

260	640	300
260	840	300
260	1040	300
260	1240	300
260	1440	300
260	1640	300

BI4102016
BI4102036
BI4102046
BI4102056
BI4102066
BI4102076

BI4152012
BI4152032
BI4152042
BI4152052
BI4152062
BI4152072

### Wooden counter shelf with front panel for rectangular counter - end

High pressure laminate (HPL) counter shelf and melamine coated/veneer front panel.

H x W x D  
mm

Item no.  
HPL & melamine

Item no.  
HPL & veneer

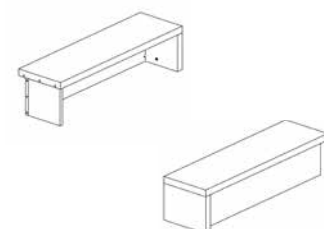

260	640	300
260	840	300
260	1040	300
260	1240	300
260	1440	300
260	1640	300

BI4103016
BI4103036
BI4103046
BI4103056
BI4103066
BI4103076

BI4153012
BI4153032
BI4153042
BI4153052
BI4153062
BI4153072

### Wooden counter shelf with front panel for rectangular counter - freestanding

High pressure laminate (HPL) counter shelf and melamine coated/veneer front panel.

H x W x D  
mm

Item no.  
HPL & melamine

Item no.  
HPL & veneer

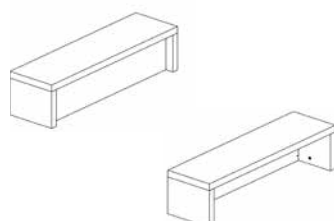

260	680	300
260	880	300
260	1080	300
260	1280	300
260	1480	300
260	1680	300

BI4104016
BI4104036
BI4104046
BI4104056
BI4104066
BI4104076

BI4154012
BI4154032
BI4154042
BI4154052
BI4154062
BI4154072



# COUNTER SHELF

## COUNTER SHELVES FOR CORNER COUNTERS

Create a private working space by adding a counter shelf to your standard corner counter. It has both practical and optical advantages.

---

### Wooden counter shelf with front panel for corner counter - starter

High pressure laminate (HPL) counter shelf and melamine coated/veneer front panel.

H x W x D  
mm  
260 800 300

Item no.  
HPL & melamine  
BI4201036

Item no.  
HPL & veneer  
BI4251032

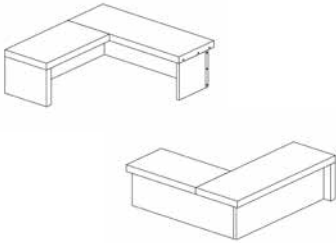

---

### Wooden counter shelf with front panel for corner counter - middle

High pressure laminate (HPL) counter shelf and melamine coated/veneer front panel.

H x W x D  
mm  
260 800 300

Item no.  
HPL & melamine  
BI4202036

Item no.  
HPL & veneer  
BI4252032

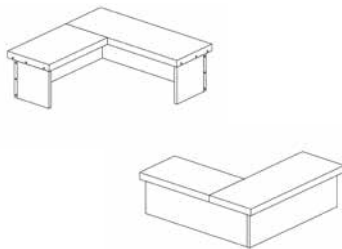

---

### Wooden counter shelf with front panel for corner counter - end

High pressure laminate (HPL) counter shelf and melamine coated/veneer front panel.

H x W x D  
mm  
260 800 300

Item no.  
HPL & melamine  
BI4203036

Item no.  
HPL & veneer  
BI4253032

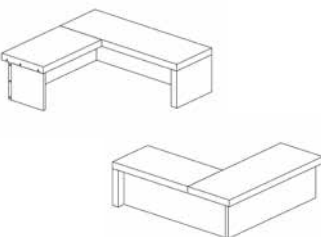

---

### Wooden counter shelf with front panel for corner counter - freestanding

High pressure laminate (HPL) counter shelf and melamine coated/veneer front panel.

H x W x D  
mm  
260 800 300

Item no.  
HPL & melamine  
BI4204036

Item no.  
HPL & veneer  
BI4254032

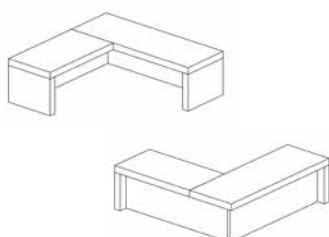

# COUNTER SHELF

## COUNTER SHELVES FOR 45° COUNTER

Create a private working space by adding a counter shelf to your curved counter. It has both practical and optical advantages.

---

### Wooden counter shelf with front panel for 45° counter - starter

High pressure laminate (HPL) counter shelf and HPL/veneer front panel.

H x D  
mm

Item no.  
HPL

Item no.  
HPL & veneer

260 300

BI431143

BI435142

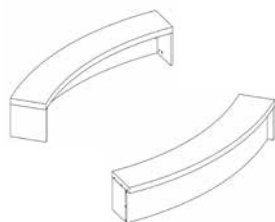

---

### Wooden counter shelf with front panel for 45° counter - middle

High pressure laminate (HPL) counter shelf and HPL/veneer front panel.

H x D  
mm

Item no.  
HPL

Item no.  
HPL & veneer

260 300

BI431243

BI435242

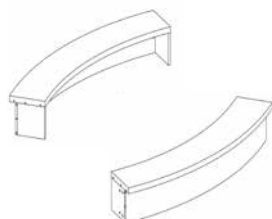

---

### Wooden counter shelf with front panel for 45° counter - end

High pressure laminate (HPL) counter shelf and HPL/veneer front panel.

H x D  
mm

Item no.  
HPL

Item no.  
HPL & veneer

260 300

BI431343

BI435342

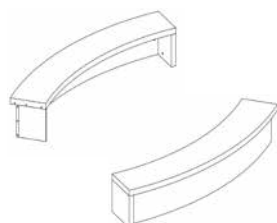

---

### Wooden counter shelf with front panel for 45° counter - freestanding

High pressure laminate (HPL) counter shelf and HPL/veneer front panel.

H x D  
mm

Item no.  
HPL

Item no.  
HPL & veneer

260 300

BI431443

BI435442

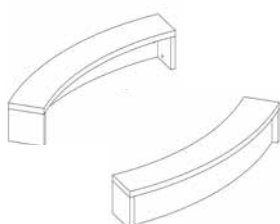

# COUNTER SHELF

## COUNTER SHELVES FOR 90° COUNTER

Create a private working space by adding a counter shelf to your curved counter. It has both practical and optical advantages.

---

### Wooden counter shelf with front panel for 90° counter- starter

High pressure laminate (HPL) counter shelf and HPL/veneer front panel.

H x D  
mm

Item no.  
HPL

Item no.  
HPL & veneer

260 300

BI431193

BI435192

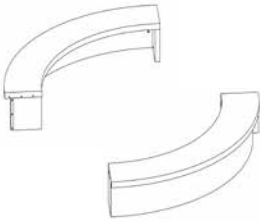

---

### Wooden counter shelf with front panel for 90° counter - middle

High pressure laminate (HPL) counter shelf and HPL/veneer front panel.

H x D  
mm

Item no.  
HPL

Item no.  
HPL & veneer

260 300

BI431293

BI435292

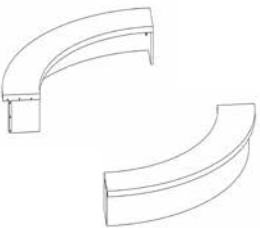

---

### Wooden counter shelf with front panel for 90° counter - end

High pressure laminate (HPL) counter shelf and HPL/veneer front panel.

H x D  
mm

Item no.  
HPL

Item no.  
HPL & veneer

260 300

BI431393

BI435392

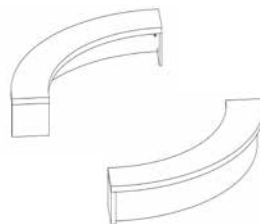

---

### Wooden counter shelf with front panel for 90° counter - freestanding

High pressure laminate (HPL) counter shelf and HPL/veneer front panel.

H x D  
mm

Item no.  
HPL

Item no.  
HPL & veneer

260 300

BI431493

BI435492

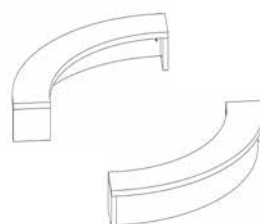

# DISPLAY AND STORAGE

CONFIGURATION NO. 18

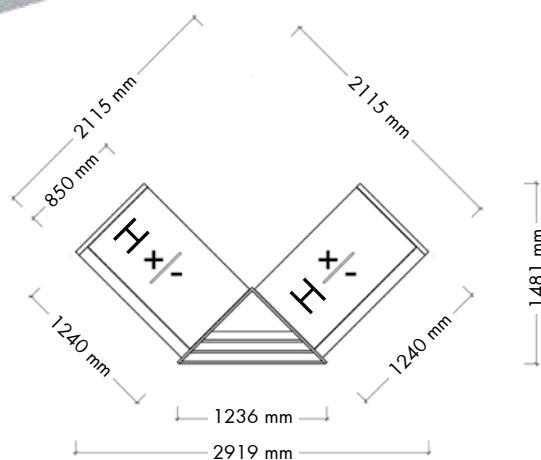

## Rectangular height adjustable counters and corner display unit

Components	Article no.	Quantity
Left side panel for height adjustable counter (H740 mm)	BI3804303	1
Height adjustable counter - starter, middle and end (W1200 mm)	BI24015006	2
Acrylic front panel for height adjustable counter (W1200 x H740 mm)	BI360543	2
Corner display unit (H870 mm)	BI5105336	1
Right side panel for height adjustable counter (H740 mm)	BI3804313	1

### Comments to configuration

- Monitor, display and text are not included in price.
- All prices are based on colours and surfaces in price group A, see pages 4-7 for colours.
- We recommend the use of desk grommets, cable rails and drawer pedestals with the Inform counter, see page 113.

# DISPLAY AND STORAGE

## CORNER DISPLAY UNITS

This is a slender corner solution with a presentation function towards the customer. The front-side shelves provide perfect storage for loose pamphlets, as well as for books and DVD's. The display unit also structures your counter and offers space e.g. book stands at standing height. The display units are ready for direct integration into all parts of the Inform counter. When constructing your counter, remember always to construct your counter from left to right when sitting behind the counter!

### H870 mm - corner display unit

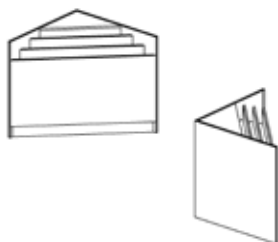

H	x	W	x	Front	Item no.	Item no.
		mm			Melamine	Veneer
870		875		1200	BI5105006	BI5105002

To have the correct positioning of drill holes in combination with other counters or cabinets, you must use the following in the article number:

		Left panel	Right panel
No drill holes for connecting fittings	BI5105	0	0
Drill holes for counter height 740 mm	BI5105	2	2
Drill holes for height adjustable counter	BI5105	3	3
Drill holes for recessed counter	BI5105	4	4

### H1130 mm - corner display unit

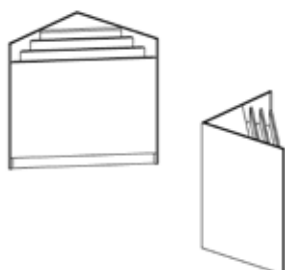

H	x	W	x	Front	Item no.	Item no.
		mm			Melamine	Veneer
1130		875		1200	BI5107006	BI5107002

To have the correct positioning of drill holes in combination with other counters or cabinets, you must use the following in the article number:

		Left panel	Right panel
No drill holes for connecting fittings	BI5107	0	0
Drill holes for standing height 1000 mm	BI5107	1	1
Drill holes for counter height 740 mm	BI5107	2	2
Drill holes for height adjustable counter	BI5107	3	3
Drill holes for recessed counter	BI5107	4	4

# DISPLAY AND STORAGE

CONFIGURATION NO. 19

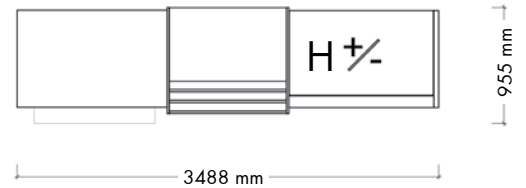

## Rectangular height adjustable and rectangular counters with display cabinet

Components	Article no.	Quantity		
Left side panel for height adjustable counter (H740 mm)	BI3804303	-	1	-
Height adjustable counter - starter, middle and end (W1200 mm)	BI24015006	-	1	-
Wooden front panel for height adjustable counter (W1200 x H740 mm)	BI350546	-	1	-
Display cabinet with shelves & pamphlet display (W1008 x H870 mm)	BI515115006	-	1	-
Rectangular counter - end (W1240 x H740 mm)	BI2003022003	-	1	-
Wooden front panel for rectangular counter (W1200 x H740 mm)	BI300546	-	1	-
Wooden bag shelf for rectangular counter (W1200 mm)	BI81053	-	1	-

### Comments to configuration

- Monitor and text are not included in price.
- All prices are based on colours and surfaces in price group A, see pages 4-7 for colours.
- We recommend the use of desk grommets, cable rails and drawer pedestals with the Inform counter, see page 113.
- The bag shelf is in fact 1000 mm long, adapted to a 1200 mm front panel.

# DISPLAY AND STORAGE

## DISPLAY CABINETS WITH STORAGE

This is a cabinet with double function: Display at the front and cabinet at the back! Inserted shelves at the front provide perfect storage for loose pamphlets, as well as for books and DVD's. The cabinet offers practical additional surface when standing behind the counter and comes in different heights and widths. The cabinets are ready for direct integration with rectangular, curved and height adjustable counters. The open back of the cabinet can be equipped with lockable doors.

### H870 mm - display cabinet with shelves at the back and pamphlet display in front

With bottom shelf and one middle shelf at the back. Doors can be installed on back of display cabinet, see page 100.

H	x	W	x	D	Item no.	Item no.
					Melamine	Veneer
870	758	875			BI515715006	BI515715002
870	908	875			BI515915006	BI515915002
870	1008	875			BI515115006	BI515115002

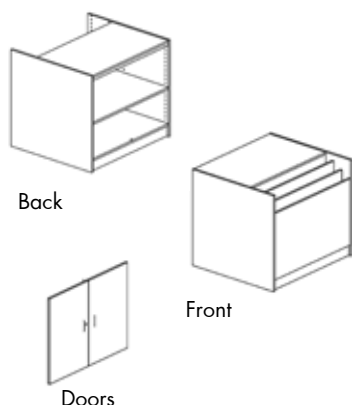

To have the correct positioning of drill holes in combination with other counters or cabinets, you must use the following in the article number:

		Left panel	Right panel
No drill holes for connecting fittings	BI515715	0	0
Drill holes for counter height 740 mm	BI515715	2	2
Drill holes for height adjustable counter	BI515715	3	3
Drill holes for recessed counter	BI515715	4	4

### H1130 mm - display cabinet with shelves at the back and pamphlet display in front

With bottom shelf and two middle shelves at the back. Doors can be installed on back of display cabinet, see page 100.

H	x	W	x	D	Item no.	Item no.
					Melamine	Veneer
1130	758	875			BI515727006	BI515727002
1130	908	875			BI515927006	BI515927002
1130	1008	875			BI515127006	BI515127002

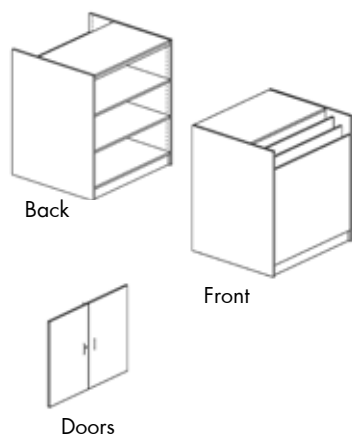

To have the correct positioning of drill holes in combination with other counters or cabinets, you must use the following in the article number:

		Left panel	Right panel
No drill holes for connecting fittings	BI515727	0	0
Drill holes for standing height 1000 mm	BI515727	1	1
Drill holes for counter height 740 mm	BI515727	2	2
Drill holes for height adjustable counter	BI515727	3	3
Drill holes for recessed counter	BI515727	4	4

# DISPLAY AND STORAGE

CONFIGURATION NO. 20

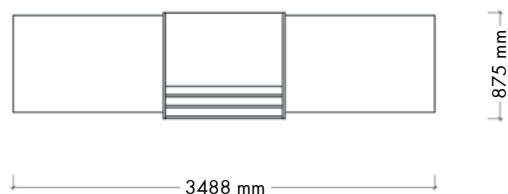

## Rectangular counters with display cabinet with drawers

Components	Article no.	Quantity		
Rectangular counter - starter (W1240 x H740 mm)	BI2001022003	-	1	-
Rectangular counter - end (W1240 x H740 mm)	BI2003022003	-	1	-
Wooden front panel for rectangular counter (W1200 x H740 mm)	BI300546	-	2	-
Display cabinet with drawers & pamphlet display (W865 x H870 mm)	BI520943006	-	1	-

### Comments to configuration

- Monitor, drawer pedestal and keyboard are not included in price.
- All prices are based on colours and surfaces in price group A, see pages 4-7 for colours.
- We recommend the use of desk grommets, cable rails and drawer pedestals with the Inform counter, see page 113.



# DISPLAY AND STORAGE

## DISPLAY CABINETS WITH DRAWERS

This is a cabinet similar to the display cabinet with storage: It has the same front display, but with drawers at the back. Inserted shelves at the front provide perfect storage for loose pamphlets, as well as for books and DVD's. The drawers at the back are designed for organising different media by use of mobile dividers. The drawers are lockable and with drawer stop, which prevents the cabinet from tilting, when several drawers are open at the same time.

### H895 mm - display cabinet with drawers at the back and pamphlet display in front

With 4 drawers. See page 100 for accessories for drawers.

H x W x D mm	Item no. Melamine	Item no. Veneer
895 865 894	BI520943006	BI520943002

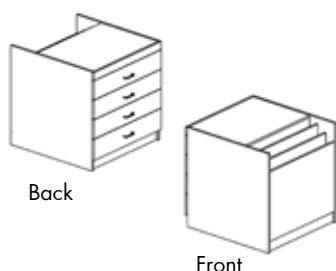

To have the correct positioning of drill holes in combination with other counters or cabinets, you must use the following in the article number:

	Item no.	Left panel	Right panel
No drill holes for connecting fittings	BI520943	0	0
Drill holes for counter height 740 mm	BI520943	2	2
Drill holes for height adjustable counter	BI520943	3	3
Drill holes for recessed counter	BI520943	4	4

### H1130 mm - display cabinet with drawers at the back and pamphlet display in front

With 5 drawers. See page 100 for accessories for drawers.

H x W x D mm	Item no. Melamine	Item no. Veneer
1130 865 894	BI520957006	BI520957002

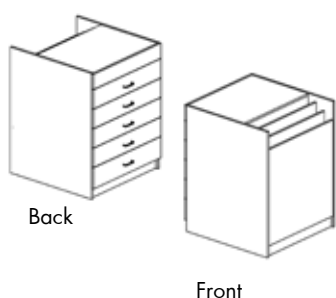

To have the correct positioning of drill holes in combination with other counters or cabinets, you must use the following in the article number:

	Item no.	Left panel	Right panel
No drill holes for connecting fittings	BI520957	0	0
Drill holes for standing height 1000 mm	BI520957	1	1
Drill holes for counter height 740 mm	BI520957	2	2
Drill holes for height adjustable counter	BI520957	3	3
Drill holes for recessed counter	BI520957	4	4

# DISPLAY AND STORAGE

## DISPLAY CABINETS WITH SHELVES AND SHELVING OPTIONS

Another cabinet with double function: Optional front display shelves and storage at the back! The front-side shelves (not included in price of cabinet) can be adjusted and can also be tilted for presenting your new acquisitions. With different heights and widths, the cabinets are ready for direct integration with rectangular, curved and height adjustable counters. The open back of the cabinet can be equipped with lockable doors.

### H870 mm - display cabinet with shelves at the back and shelving options in the front

With bottom shelf and one middle shelf at the back. Front shelves are not included. Doors can be installed on back of display cabinet. See pages 100-101 for doors and shelves.

H x W x D mm	Item no. Melamine	Item no. Veneer
870 758 875	BI525715006	BI525715002
870 908 875	BI525915006	BI525915002
870 1008 875	BI525115006	BI525115002

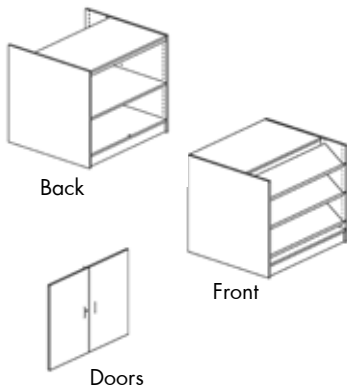

To have the correct positioning of drill holes in combination with other counters or cabinets, you must use the following in the article number:

		Left panel	Right panel
No drill holes for connecting fittings	BI5255715	0	0
Drill holes for counter height 740 mm	BI5255715	2	2
Drill holes for height adjustable counter	BI5255715	3	3
Drill holes for recessed counter	BI5255715	4	4

### H1130 mm - display cabinet with shelves at the back and shelving options in the front

With bottom shelf and two middle shelves at the back. Front shelves are not included. Doors can be installed on back of display cabinet. See pages 100-101 for doors and shelves.

H x W x D mm	Item no. Melamine	Item no. Veneer
1130 758 875	BI525727006	BI525727002
1130 908 875	BI525927006	BI525927032
1130 1008 875	BI525127006	BI525127002

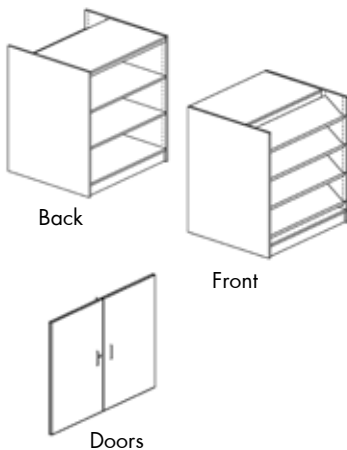

To have the correct positioning of drill holes in combination with other counters or cabinets, you must use the following in the article number:

		Left panel	Right panel
No drill holes for connecting fittings	BI525727	0	0
Drill holes for standing height 1000 mm	BI525727	1	1
Drill holes for counter height 740 mm	BI525727	2	2
Drill holes for height adjustable counter	BI525727	3	3
Drill holes for recessed counter	BI525727	4	4

# DISPLAY AND STORAGE

## DISPLAY CABINET WITH BOOK TROLLEY GARAGE

Use the space behind your counter - give your book trolley its own parking spot! You will not lose any space when you have the double function cabinet as part of your counter. At the same time, present your books or pamphlets at the front of the cabinet. The cabinets are ready for direct integration with rectangular, curved and height adjustable counters.

### H1130 mm - display cabinet with book trolley garage at the back and shelving options in front

Inner dimension of garage: H1080 x W930 x D580 mm. Front shelves are not included, see page 101.

H x W x D mm	Item no. Melamine	Item no. Veneer
1130 1008 875	BI530197006	BI530197002

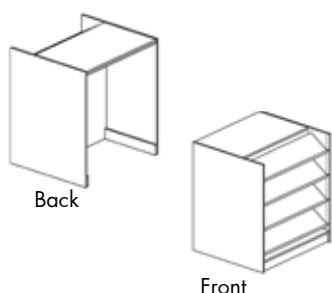

To have the correct positioning of drill holes in combination with other counters or cabinets, you must use the following in the article number:

		Left panel	Right panel
No drill holes for connecting fittings	BI530187	0	0
Drill holes for standing height 1000 mm	BI530187	1	1
Drill holes for counter height 740 mm	BI530187	2	2
Drill holes for height adjustable counter	BI530187	3	3
Drill holes for recessed counter	BI530187	4	4

### H1130 mm - display cabinet with book trolley garage at the back and pamphlet display in front

Inner dimension of garage: H1080 x W930 x D580 mm.

H x W x D mm	Item no. Melamine	Item no. Veneer
1130 1008 875	BI530187006	BI530187002

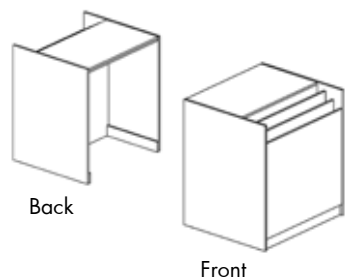

To have the correct positioning of drill holes in combination with other counters or cabinets, you must use the following in the article number:

		Left panel	Right panel
No drill holes for connecting fittings	BI530197	0	0
Drill holes for standing height 1000 mm	BI530197	1	1
Drill holes for counter height 740 mm	BI530197	2	2
Drill holes for height adjustable counter	BI530197	3	3
Drill holes for recessed counter	BI530197	4	4

# DISPLAY AND STORAGE

## ACCESSORIES

### Doors for display cabinet BI515 & BI525

With cylinder lock and door handles.



H x W mm	Item no. Melamine	Item no. Veneer
870 758	BI5407056	BI5407052
870 908	BI5409056	BI5409052
870 1008	BI5401056	BI5401052
1130 758	BI5407076	BI5407072
1130 908	BI5409076	BI5409072
1130 1008	BI5401076	BI5401072

### Drawer organizer for display cabinet BI520

To organise media. Incl. silver coloured steel dividers, two stainless steel rods, mat and four mobile dividers. For approx. 200 CDs in standard cases, 1000 CDs in plastic cases or 90 DVDs.

Description  
1 set for 1 drawer  
1 additional divider

Item no.  
B4011859  
B401186

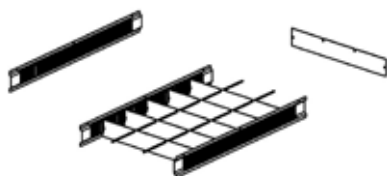

### Bracket for sloping wooden and steel shelves

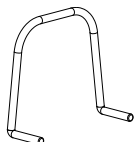

Item no.  
BN066

# DISPLAY AND STORAGE

## ACCESSORIES

### Wooden shelf with steel backedge for display cabinet BI525 & BI530

Snapfix incl. Steel backedge H47 mm.  
When turned, the shelf can be used as a sloping shelf by using the existing pins and bracket BN066.

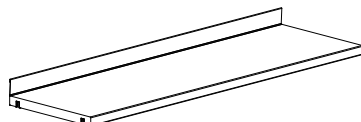

W	x	D	Type of shelf	Item no. Melamine	Item no. Veneer
mm					
500	250	Straight	B4018025216	B4018025212	
500	300	Sloping	B4018025316	B4018025312	
750	250	Straight	B4018027216	B4018027212	
750	300	Sloping	B4018027316	B4018027312	
900	250	Straight	B4018029216	B4018029212	
900	300	Sloping	B4018029316	B4018029312	
1000	250	Straight	B4018021216	B4018021212	
1000	300	Sloping	B4018021316	B4018021312	

### Wooden shelf for display cabinet BI525 & BI530

Snapfix incl.

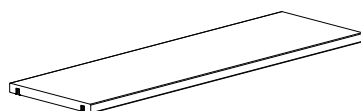

W	x	D	Type of shelf	Item no. Melamine	Item no. Veneer
mm					
500	250	Straight	B4018025206	B4018025202	
750	250	Straight	B4018027206	B4018027202	
900	250	Straight	B4018029206	B4018029202	
1000	250	Straight	B4018021206	B4018021202	

### Steel shelf with steel backedge for display cabinet BI525 & BI530

Pins incl. Steel backedge H25 mm.  
When turned, the shelf can be used as a sloping shelf by using the existing pins and bracket BN066.

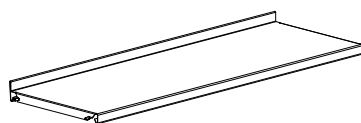

W	x	D	Type of shelf	Item no.
mm				
500	250	Straight	B401803521	B401803521
500	300	Sloping	B401803531	B401803531
750	250	Straight	B401803721	B401803721
750	300	Sloping	B401803731	B401803731
900	250	Straight	B401803921	B401803921
900	300	Sloping	B401803931	B401803931
1000	250	Straight	B401803121	B401803121
1000	300	Sloping	B401803131	B401803131

### Steel shelf for display cabinet BI525 & BI530

Pins incl.

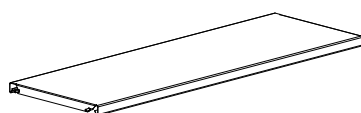

W	x	D	Type of shelf	Item no.
mm				
500	250	Straight	B401803520	B401803520
750	250	Straight	B401803720	B401803720
900	250	Straight	B401803920	B401803920
1000	250	Straight	B401803120	B401803120

# FUNCTIONS

CONFIGURATION NO. 21

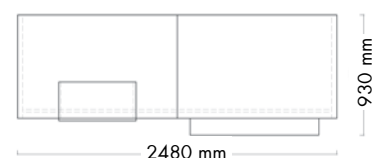

## Rectangular counters (with counter top part & bag shelf)

Components	Article no.		Quantity	
Rectangular counter - starter (W1240 x H740 mm)	BI2001022003	-	1	-
Rectangular counter - end (W1240 x H740 mm)	BI2003022003	-	1	-
Wooden front panel for rectangular counter (W1200 x H740 mm)	BI300546	-	2	-
Steel leg frame (H740 mm)	BI069146	-	1	-
Wooden counter top part with info sign (W600 x H490 mm)	BI820186	-	1	-
Wooden bag shelf for rectangular counter (W1200 mm)	BI81053	-	1	-

### Comments to configuration

- Office chair and text are not included in price.
- All prices are based on colours and surfaces in price group A, see pages 4-7 for colours.
- We recommend the use of desk grommets, cable rails and drawer pedestals with the Inform counter, see page 113.
- The bag shelf is in fact 1000 mm long, adapted to a 1200 mm front panel.

# FUNCTIONS

## BAG SHELVES

Add functions to your counter. Below you will find products that can be built on to the Inform counter to make it more functional and user friendly. The wooden bag shelves below can only be used with wooden front panels, it is not possible to use with acrylic front panels. The distance from floor to top of shelf is 55 cm.

### Wooden bag shelf for rectangular counter

Only use with wooden front panels. Do not use with acrylic front panels. Max. load 5 kg. Actual width of shelf is 200 mm shorter than the width of the counter.

Counter	Shelf	Shelf
W x	W x	D
	mm	
600	400	180
800	600	180
1000	800	180
1200	1000	180
1400	1200	180
1600	1400	180

Item no.  
HPL

BI81013  
BI81033  
BI81043  
BI81053  
BI81063  
BI81073



### Wooden bag shelf for 45° curved counter

Only use with wooden front panels. Do not use with acrylic front panels. Max. load 5 kg.

W x	D
mm	
1710	180

Item no.  
HPL

BI815453

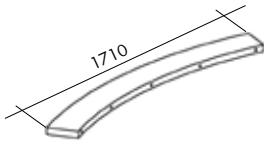

### Wooden bag shelf for 90° curved counter

Only use with wooden front panels. Do not use with acrylic front panels. Max. load 5 kg.

W x	D
mm	
1875	180

Item no.  
HPL

BI815903

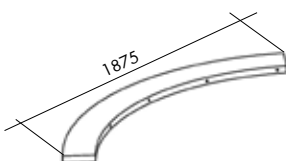

# FUNCTIONS

CONFIGURATION NO. 22

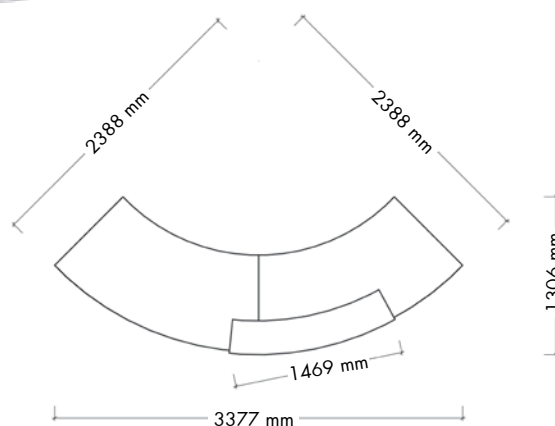

## 45° curved counters (with counter top part)

Components	Article no.	Quantity
45° curved counter - starter (H740 mm)	BI2051428003	1
45° curved counter - end (H740 mm)	BI2053428003	1
Wooden front panel for 45° curved counter (H740 mm)	BI3204543	2
Steel leg frame (H740 mm)	BI069146	1
Wooden counter top part with info sign (1400 x H490 mm)	BI82545683	1

### Comments to configuration

- Computer, office chair and text are not included in price.
- All prices are based on colours and surfaces in price group A, see pages 4-7 for colours.
- We recommend the use of desk grommets, cable rails and drawer pedestals with the Inform counter, see page 113.



# FUNCTIONS

CONFIGURATION NO. 23

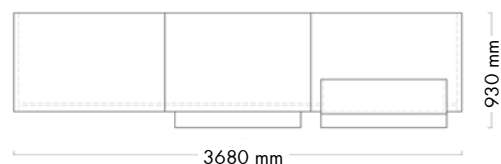

## Rectangular counters (with acrylic front panel, bag shelf & counter top part with bag shelf)

Components	Article no.		Quantity	
Rectangular counter - starter (W1240 x H740 mm)	BI2001022003	-	1	-
Rectangular counter - middle (W1200 x H740 mm)	BI2002082003	-	1	-
Wooden front panel for rectangular counter (W1200 x H740 mm)	BI300546	-	2	-
Rectangular counter - end (W1240 x H740 mm)	BI2003022003	-	1	-
Acrylic front panel for rectangular counter (W1200 x H740 mm)	BI310546	-	1	-
Steel leg frame (H740 mm)	BI069146	-	2	-
Wooden counter top part with bag shelf (W1000 x H490 mm)	BI830486	-	1	-
Wooden bag shelf (W1200 mm)	BI81053	-	1	-
Stainless steel desk grommet	B4015553	-	1	-

### Comments to configuration

- Monitor, key board, office chair and text are not included in price.
- All prices are based on colours and surfaces in price group A, see pages 4-7 for colours.
- We recommend the use of desk grommets, cable rails and drawer pedestals with the Inform counter, see page 113.
- The counter top part and bag shelf are in fact 1000 mm long, adapted to a 1200 mm front panel.

# FUNCTIONS

## COUNTER TOP PARTS WITH INFO SIGN

Add functions to your counter. Below you will find products that can be built on to the Inform counter to make it more functional and user friendly.

### Wooden counter top part with info sign for rectangular counter

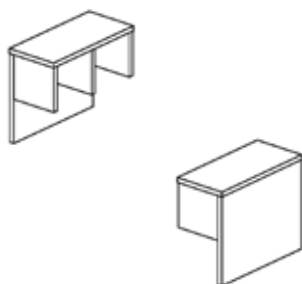

W x H x D mm (OD)	H x D mm (ID)	Item no. Melamine
600 490 280	235 250	BI820186
800 490 280	235 250	BI820386
1000 490 280	235 250	BI820486
1200 490 280	235 250	BI820586
1400 490 280	235 250	BI820686
1600 490 280	235 250	BI820786
600 580 280	325 250	BI820196
800 580 280	325 250	BI820396
1000 580 280	325 250	BI820496
1200 580 280	325 250	BI820596
1400 580 280	325 250	BI820696
1600 580 280	325 250	BI820796

### Wooden counter top part with info sign for 45° curved counter

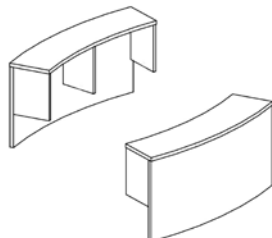

W x H x D mm (OD)	H x D mm (ID)	Item no. HPL
800 490 280	235 250	BI82545383
1000 490 280	235 250	BI82545483
1200 490 280	235 250	BI82545583
1400 490 280	235 250	BI82545683
800 580 280	325 250	BI82545393
1000 580 280	325 250	BI82545493
1200 580 280	325 250	BI82545593
1400 580 280	325 250	BI82545693

### Wooden counter top part with info sign for 90° curved counter

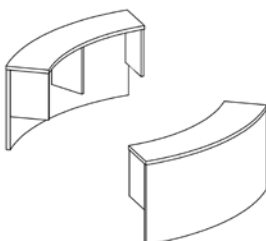

W x H x D mm (OD)	H x D mm (ID)	Item no. HPL
800 490 280	235 250	BI82590383
1000 490 280	235 250	BI82590483
1200 490 280	235 250	BI82590583
1400 490 280	235 250	BI82590683
800 580 280	325 250	BI82590393
1000 580 280	325 250	BI82590493
1200 580 280	325 250	BI82590593
1400 580 280	325 250	BI82590693

# FUNCTIONS

## COUNTER TOP PARTS WITH INFO SIGN

Add functions to your counter. Below you will find products that can be built on to the Inform counter to make it more functional and user friendly.

### Wooden counter top part with info sign for rectangular counter

	W x H x D mm (OD)			H x D mm (ID)		Item no. Veneer
		600	490	280	235	
	800	490	280	235	250	BI820382
	1000	490	280	235	250	BI820482
	1200	490	280	235	250	BI820582
	1400	490	280	235	250	BI820682
	1600	490	280	235	250	BI820782
	600	580	280	325	250	BI820192
	800	580	280	325	250	BI820392
	1000	580	280	325	250	BI820492
	1200	580	280	325	250	BI820592
	1400	580	280	325	250	BI820692
	1600	580	280	325	250	BI820792

### Wooden counter top part with info sign for 45° curved counter

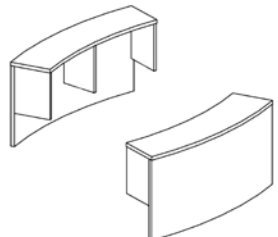
	W x H x D mm (OD)			H x D mm (ID)		Item no. Veneer
		800	490	280	235	
	1000	490	280	235	250	BI82545482
	1200	490	280	235	250	BI82545582
	1400	490	280	235	250	BI82545682
	800	580	280	325	250	BI82545392
	1000	580	280	325	250	BI82545492
	1200	580	280	325	250	BI82545592
	1400	580	280	325	250	BI82545692

### Wooden counter top part with info sign for 90° curved counter

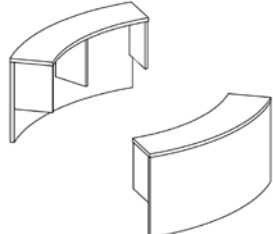
	W x H x D mm (OD)			H x D mm (ID)		Item no. Veneer
		800	490	280	235	
	1000	490	280	235	250	BI82590482
	1200	490	280	235	250	BI82590582
	1400	490	280	235	250	BI82590682
	800	580	280	325	250	BI82590392
	1000	580	280	325	250	BI82590492
	1200	580	280	325	250	BI82590592
	1400	580	280	325	250	BI82590692

# FUNCTIONS

## COUNTER TOP PARTS WITH BAG SHELF

Add functions to your counter. Below you will find products that can be built on to the Inform counter to make it more functional and user friendly. The counter top parts can only be used with wooden front panels, it is not possible to use with acrylic front panels.

### Wooden counter top part with bag shelf for rectangular counter

Max. load 5 kg.

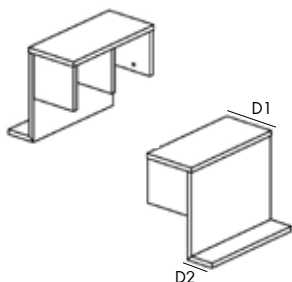

W x H x D1 x D2 mm (OD)	H x D mm (ID)	Item no. Melamine
600 490 280 130	235 250	BI830186
800 490 280 130	235 250	BI830386
1000 490 280 130	235 250	BI830486
1200 490 280 130	235 250	BI830586
1400 490 280 130	235 250	BI830686
1600 490 280 130	235 250	BI830786
600 580 280 130	325 250	BI830196
800 580 280 130	325 250	BI830396
1000 580 280 130	325 250	BI830496
1200 580 280 130	325 250	BI830596
1400 580 280 130	325 250	BI830696
1600 580 280 130	325 250	BI830796

### Wooden counter top part with bag shelf for 45° curved counter

Max. load 5 kg.

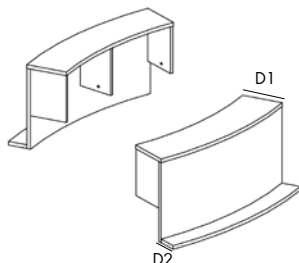

W x H x D1 x D2 mm (OD)	H x D mm (ID)	Item no. HPL
800 490 280 130	235 250	BI83545383
1000 490 280 130	235 250	BI83545483
1200 490 280 130	235 250	BI83545583
1400 490 280 130	235 250	BI83545683
800 580 280 130	325 250	BI83545393
1000 580 280 130	325 250	BI83545493
1200 580 280 130	325 250	BI83545593
1400 580 280 130	325 250	BI83545693

### Wooden counter top part with bag shelf for 90° curved counter

Max. load 5 kg.

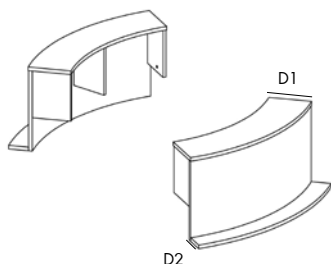

W x H x D1 x D2 mm (OD)	H x D mm (ID)	Item no. HPL
800 490 280 130	235 250	BI83590383
1000 490 280 130	235 250	BI83590483
1200 490 280 130	235 250	BI83590583
1400 490 280 130	235 250	BI83590683
800 580 280 130	325 250	BI83590493
1000 580 280 130	325 250	BI83590593
1200 580 280 130	325 250	BI83590693
1400 580 280 130	325 250	BI83590393

# FUNCTIONS

## COUNTER TOP PARTS WITH BAG SHELF

Add functions to your counter. Below you will find products that can be built on to the Inform counter to make it more functional and user friendly. The counter top parts can only be used with wooden front panels, it is not possible to use with acrylic front panels.

### Wooden counter top part with bag shelf for rectangular counter

Max. load 5 kg.

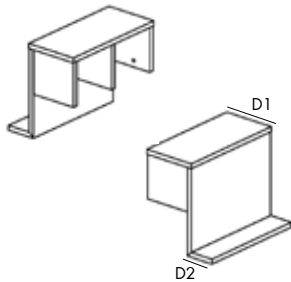

W x H x D1 x D2 mm (OD)	H x D mm (ID)	Item no. Veneer
600 490 280 130	235 250	BI830182
800 490 280 130	235 250	BI830382
1000 490 280 130	235 250	BI830482
1200 490 280 130	235 250	BI830582
1400 490 280 130	235 250	BI830682
1600 490 280 130	235 250	BI830782
600 580 280 130	325 250	BI830192
800 580 280 130	325 250	BI830392
1000 580 280 130	325 250	BI830492
1200 580 280 130	325 250	BI830592
1400 580 280 130	325 250	BI830692
1600 580 280 130	325 250	BI830792

### Wooden counter top part with bag shelf for 45° curved counter

Max. load 5 kg.

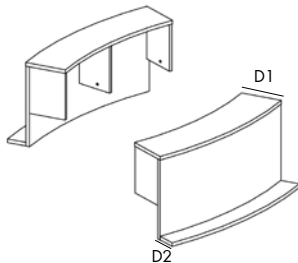

W x H x D1 x D2 mm (OD)	H x D mm (ID)	Item no. Veneer
800 490 280 130	235 250	BI83545382
1000 490 280 130	235 250	BI83545482
1200 490 280 130	235 250	BI83545582
1400 490 280 130	235 250	BI83545682
800 580 280 130	325 250	BI83545392
1000 580 280 130	325 250	BI83545492
1200 580 280 130	325 250	BI83545592
1400 580 280 130	325 250	BI83545692

### Wooden counter top part with bag shelf for 90° curved counter

Max. load 5 kg.

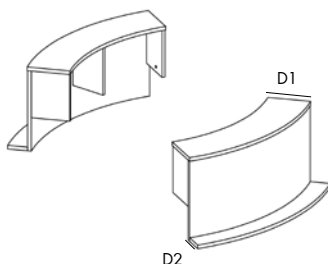

W x H x D1 x D2 mm (OD)	H x D mm (ID)	Item no. Veneer
800 490 280 130	235 250	BI83590382
1000 490 280 130	235 250	BI83590482
1200 490 280 130	235 250	BI83590582
1400 490 280 130	235 250	BI83590682
800 580 280 130	325 250	BI83590392
1000 580 280 130	325 250	BI83590492
1200 580 280 130	325 250	BI83590592
1400 580 280 130	325 250	BI83590692

# FUNCTIONS

CONFIGURATION NO. 24

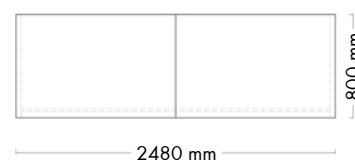

## Rectangular counters (with decorative boards)

Components	Article no.		Quantity	
Rectangular counter - starter (W1240 x H740 mm)	BI2001022003	-	1	-
Rectangular counter - end (W1240 x H740 mm)	BI2003022003	-	1	-
Wooden front panel for rectangular counter (W1200 x H740 mm)	BI300546	-	2	-
Steel leg frame (H740 mm)	BI069146	-	1	-
Wooden decorative board - high (W600 x H740 mm)	BI840146	-	1	-
Wooden decorative board - narrow (W600 x H190 mm)	BI845116	-	1	-

### Comments to configuration

- Office chair and text are not included in price.
- All prices are based on colours and surfaces in price group A, see pages 4-7 for colours.
- We recommend the use of desk grommets, cable rails and drawer pedestals with the Inform counter, see page 113.

# FUNCTIONS

## DECORATIVE BOARDS AND INFO SIGNS

### Wooden decorative board - high

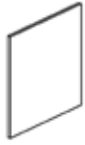

W	x	H	x	D	Item no. Melamine	Item no. Veneer
				mm		
600	740	19			BI840146	BI840142
600	1000	19			BI840166	BI840162

### Wooden decorative board - narrow

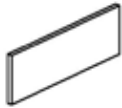

W	x	H	x	D	Item no. Melamine	Item no. Veneer
				mm		
600	190	19			BI845116	BI845112
800	190	19			BI845316	BI845312
1000	190	19			BI845416	BI845412
1200	190	19			BI845516	BI845512
1400	190	19			BI845616	BI845612
1600	190	19			BI845716	BI845712

### Wooden info sign

Melamine/veneer board. Only use with wooden front panels. Do not use with acrylic front panels.

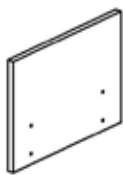

W	x	H	x	D	Item no. Melamine	Item no. Veneer
				mm		
600	430	25			BI850126	BI850122
800	430	25			BI850326	BI850322
1000	430	25			BI850426	BI850422
1200	430	25			BI850526	BI850522

### Acrylic info sign (se configuration no 25.)

Acrylic frosted white glazed board. Only use with wooden front panels. Do not use with acrylic front panels.

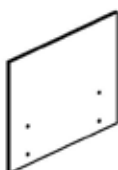

W	x	H	x	D	Item no. Acrylic
				mm	
600	430	10			BI85512
800	430	10			BI85532
1000	430	10			BI85542
1200	430	10			BI85552

# FUNCTIONS

CONFIGURATION NO. 25



## Rectangular counters (with acrylic info sign, desk grommet and monitor arm)

Components	Article no.	Quantity		
Rectangular counter - starter (W1240 x H740 mm)	BI2001022003	-	1	-
Rectangular counter - end (W1240 x H740 mm)	BI2003022003	-	1	-
Wooden front panel for rectangular counter (W1200 x H740 mm)	BI300546	-	1	-
Acrylic front panel for rectangular counter (W1200 x H740 mm)	BI310546	-	1	-
Steel leg frame (H740 mm)	BI069146	-	1	-
Info sign - acrylic frosted white glazed (W600 x H430 mm)	BI85512	-	1	-
Monitor arm	B401184	-	1	-

### Comments to configuration

- Monitor, office chair and text are not included in price.
- All prices are based on colours and surfaces in price group A, see pages 4-7 for colours.
- We recommend the use of desk grommets, cable rails and drawer pedestals with the Inform counter, see page 113.
- It is necessary to drill an Ø80 mm hole for the monitor arm on site or modify the article number for counter for predrilled hole, see pages 120-121.



# FUNCTIONS

## FUNCTIONAL ACCESSORIES

### Desk grommet

Ø80 mm. Drill hole is not included.  
For placement of drill hole, see cable  
conduct on pages 122-123.



Material	Colour	Item no.
Plastic	Oyster white	B4015548
Plastic	Black	B4015542
Plastic	Silver	B4015549
Metal	Stainless steel	B4015553

### Monitor arm

Silver. For placement of drill hole, see  
cable conduct on pages 120-121. Drill  
holes for monitor arm will most often be  
drilled on site.



Item no.

B401184

### CPU holder

W230 x H551 x D500 mm. Laquered  
steel. Practical storage of CPU holder  
under counter. Does not fit with recessed  
counter.

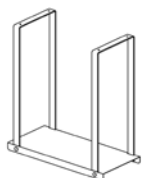

Item no.

B401180

### Cable channel

W495 x H70 x D115 mm. Laquered  
steel. Is bendable - can be used with  
both straight and curved counters. For  
required quantities, see below.

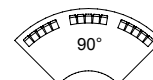
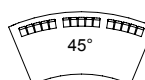
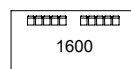
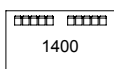
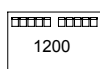

Item no.

B401182A28

### Drawer pedestal

W442 x H615 x D585 mm.  
With office supplies drawer  
and 2/3 drawers.

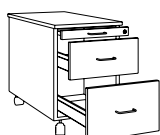

Drawers	Item no. Melamine	Item no. Veneer
1 drawer (128 mm)	B401195256	B401195252
1 drawer (320 mm)		
1 drawer (192 mm)	B401195346	B401195342
1 drawer (256 mm)		
2 drawers (128 mm)	B401195236	B401195232
1 drawer (192 mm)		

# FUNCTIONS

## POWER SOCKETS

### Power socket Square 80

W181 x D96 mm with lid open.  
With sliding lid.  
Mounting hole Ø80 mm.  
Worktop thickness 10-50 mm.  
3 m cable length.

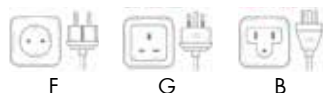

Colour	USB	Type	Market	Item no.
Black	1	1 x F	BE/DE/DK/FR/SE	B4015002101
White	1	1 x F	BE/DE/DK/FR/SE	B4015001101
Black	1	1 x G	GB	B4015002311
White	1	1 x G	GB	B4015001311
Black	1	1 x B	US	B4015002221

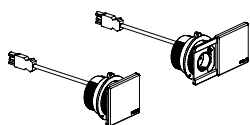

### Built-in power socket BackFlip

W225 x D105 mm.  
Lid flips 180 deg.  
Mounting depth 53 mm.  
Worktop thickness 10-40 mm.  
2,5 m cable length.

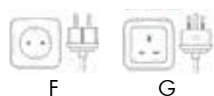

Colour	USB	Type	Market	Item no.
Stainless steel	2	2 x F	BE/DE/DK/FR/SE	B4015013102
Stainless steel	2	2 x G	GB	B4015013312

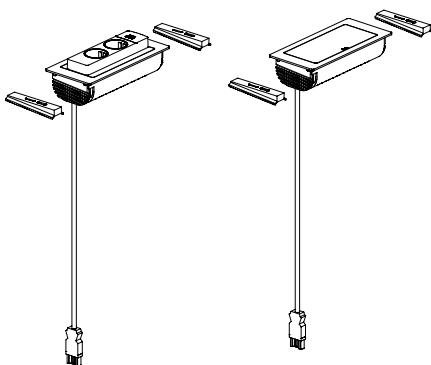

# FUNCTIONS

## POWER SOCKETS

### Built-in power socket FlipTop Push

W260 x D167 mm.

Open lid with soft touch.

Mounting depth 68 mm.

Worktop thickness 10-50 mm.

3 m cable length.

Colour	USB	Type	Market	Item no.
Stainless steel	2	3 x F	BE/DE/DK/FR/SE	B4015023103
Stainless steel	2	2 x G	GB	B4015023312

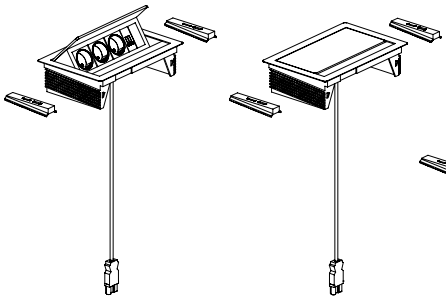

### Built-in power socket FrameDock

W260 x D167 mm.

Mounting depth 51 mm.

Worktop thickness 5-38 mm.

3 m cable length.

Colour	USB	Type	Market	Item no.
Black	2	3 x F	BE/DE/DK/FR/SE	B4015032103
White	2	3 x F	BE/DE/DK/FR/SE	B4015031103
Black	2	2 x G	GB	B4015032312
Black	2	2 x B	US	B4015032222

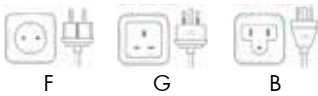

# FRONT PANEL OPTIONS

CONFIGURATION NO. 26

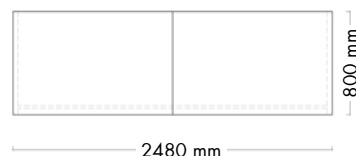

## Rectangular counters (with acrylic front panels and lighting)

Components	Article no.		Quantity	
Rectangular counter - starter (W1240 x H740 mm)	BI2001022003	-	1	-
Rectangular counter - end (W1240 x H740 mm)	BI2003022003	-	1	-
Acrylic front panel for rectangular counter (W1200 x H740 mm)	BI310546	-	2	-
Light for acrylic front panel (W1200 mm)	BI86051	-	2	-
Steel leg frame (H740 mm)	BI069146	-	1	-
Monitor arm	B401184	-	1	-

### Comments to configuration

- Monitor and office chair are not included in price.
- All prices are based on colours and surfaces in price group A, see pages 4-7 for colours.
- We recommend the use of desk grommets, cable rails and drawer pedestals with the Inform counter, see page 113.
- It is necessary to drill an Ø80 mm hole for the monitor arm on site or modify the article number for counter for predrilled hole, see pages 120-121.
- Above article number for light is for German voltage and plug. Contact Sales for further information on voltage and plug for other countries.

# FRONT PANEL OPTIONS

## LED LIGHT

Create your own individual counter! You can differentiate your counter by use of acrylic front panels with light. See Design Options for acrylic front panel options. Note - the LED lighting can only be used for Standard Inform rectangular and curved counters.

---

### Light for rectangular counter with acrylic front panel

Light mounted underneath table top on the inside of the counter. With cable and plug for the European market (except UK). Contact sales for plug and voltage for other countries.	W counter	W lamp	Watt	Item no.
	800	595	1 x 14W	BI86031
	1000	895	1 x 21W	BI86041
	1200	895	1 x 21W	BI86051
	1400	1195	1 x 28W	BI86061
	1600	1495	1 x 35W	BI86071

---

### Light for 45° and 90° curved counter with acrylic front panel

Light mounted underneath table top on the inside of the counter. With cable and plug for the European market (except UK). Contact sales for plug and voltage for other countries.	Deg.	W lamp	Watt	Item no.
	45°	595	2 x 14W	BI862451
	90°	595	2 x 14W	BI862901

---

# FRONT PANEL OPTIONS

CONFIGURATON NO. 27

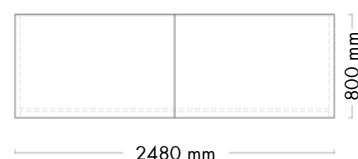

## Rectangular counters (with graphics on wooden front panel)

Components	Article no.	Quantity		
Rectangular counter - starter (W1240 x H740 mm)	BI2001022003	-	1	-
Rectangular counter - end (W1240 x H740 mm)	BI2003022003	-	1	-
Wooden front panel for rectangular counter (W1200 x H740 mm)	BI300546	-	2	-
Additional graphics to wooden front panel (W1200 x H740 mm)	BI86454	-	2	-
Steel leg frame (H740 mm)	BI069146	-	1	-
Monitor arm	B401184	-	1	-

### Comments to configuration

- Monitor, key board and office chair are not included in price.
- All prices are based on colours and surfaces in price group A, see pages 4-7 for colours.
- We recommend the use of desk grommets, cable rails and drawer pedestals with the Inform counter, see page 113.
- It is necessary to drill an Ø80 mm hole for the monitor arm on site or modify the article number for counter for predrilled hole, see pages 120-121.

# FRONT PANEL OPTIONS

## GRAPHICS

Create your own individual counter! Use the front of the counter as a display for your ideas. The Inform counter gives you the opportunity to design all wooden front panels in accordance with your wishes and requirements. Use pictures, graphics or text to make a statement!

---

### Front image for rectangular front panel

Price for full size sticker. Smaller stickers and logos on request. Price excl. front panel.	H	W	Item no.
	mm		
	740	600	BI86414
	740	800	BI86434
	740	1000	BI86444
	740	1200	BI86454
	740	1400	BI86464
	740	1600	BI86474
	1000	600	BI86416
	1000	800	BI86436
	1000	1000	BI86446
	1000	1200	BI86456
	1000	1400	BI86466
	1000	1600	BI86476

---

### Front image for 45° curved front panel

Price for full size sticker. Smaller stickers and logos on request. Price excl. front panel.	H	W	Item no.
	mm		
	740	1830	BI866454
	1000	1850	BI866456

---

### Front image for 90° curved front panel

Price for full size sticker. Smaller stickers and logos on request. Price excl. front panel.	H	W	Item no.
	mm		
	740	1830	BI866904
	1000	1850	BI866906

---

### Front image for corner front panel

Price for full size sticker. Smaller stickers and logos on request. Price excl. front panel.	H	W	Item no.
	mm		
	740	800	BI8684
	1000	800	BI8686

---

### Text for front panel

Item no.
B400003

# DRILL HOLES

## FOR CABLE CONDUCT

It is possible to have counters delivered with predrilled holes and desk grommets for cable conduct. There is a surcharge per drill hole and desk grommet. Please inform Customer Service where you would like the predrilled hole to be placed (0-7) and which desk grommet (0/2/3/8/9) you would like. Remember to view the counter from left to right, as if sitting behind the counter.

### Drill hole for desk grommet for rectangular, step and height adjustable counters

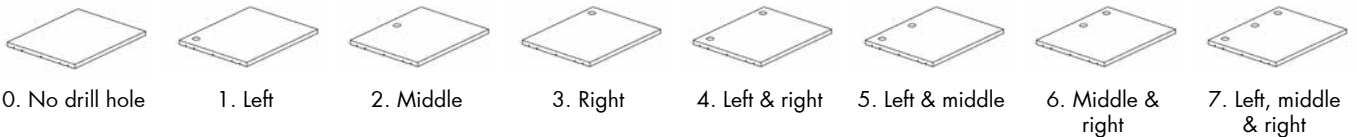

### Drill hole for desk grommet for recessed rectangular counters

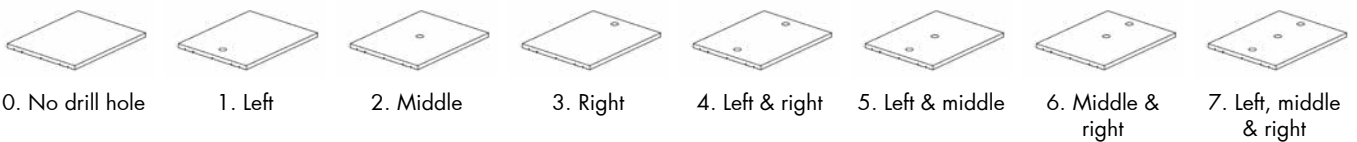

### Drill hole for desk grommet for 45° and 90° curved counters

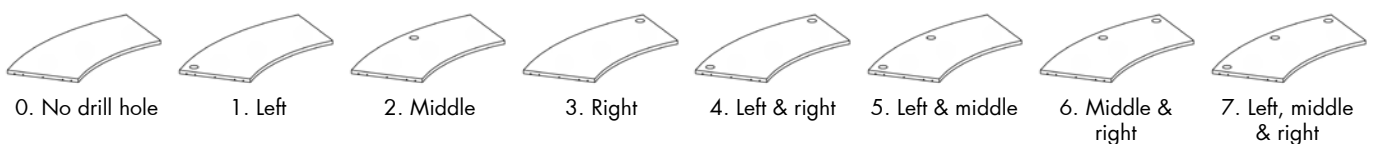

### Drill hole for desk grommet for 45° and 90° recessed curved counters

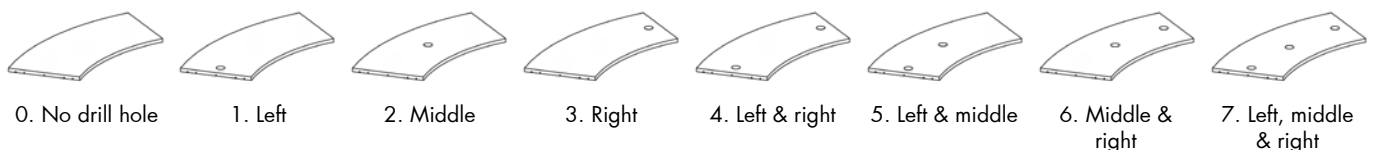



# DRILL HOLES

## FOR CABLE CONDUCT

It is possible to have counters delivered with predrilled holes and desk grommets for cable conduct. There is a surcharge per drill hole and desk grommet. Please inform Customer Service where you would like the predrilled hole to be placed (0-7) and which desk grommet (0/2/3/8/9) you would like. Remember to view the counter from left to right, as if sitting behind the counter.

### Drill hole for desk grommet for corner counter - side A

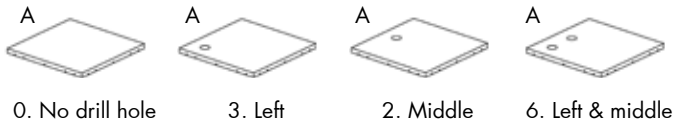

### Drill hole for desk grommet for corner counter - side B

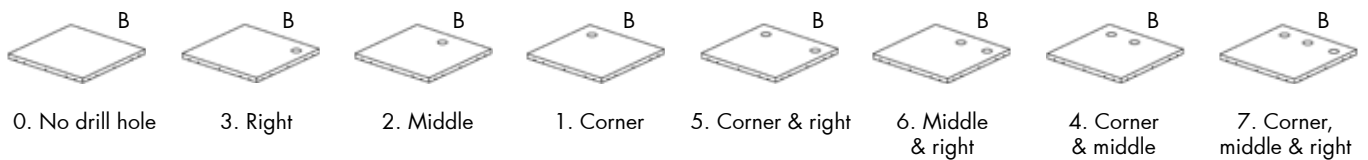

### Drill hole for desk grommet for triangular corner counter

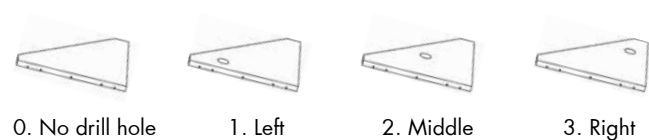

### Desk grommet

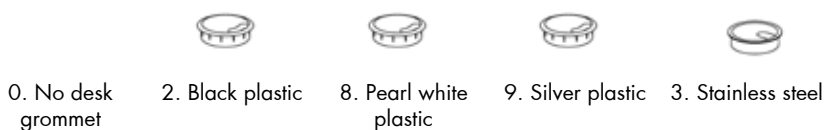

# RFID INSTALLATION

## PREPARATION FOR INSTALLATION OF RFID IN COUNTERTOP

The Inform counter offers the option to install an RFID PCB under the countertop, whether straight, curved or height adjustable. The 40 mm thick countertop is recessed below the central section to allow for the optimal positioning of the RFID PCB as needed. As far as the dimension of the countertop is concerned, the central recessed section leaves a peripheral circumference of 80 mm to 110 mm to preserve the visual aesthetics of the 40 mm top. In the recessed section, the countertop is 20 mm thick, thus complying with the technical specifications of most RFID systems for counters.

---

### RFID installation in rectangular counter

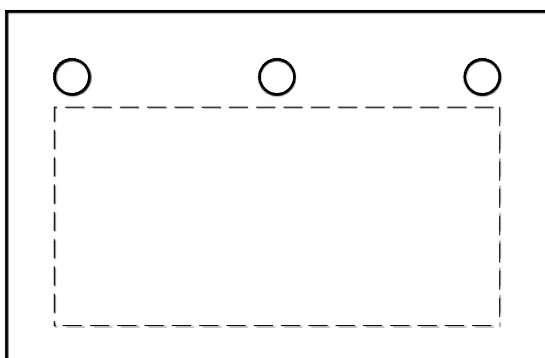

### RFID installation in recessed rectangular counter

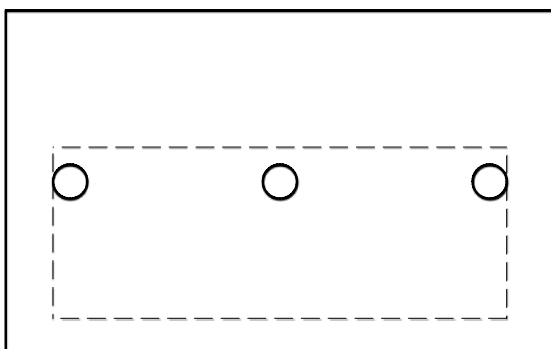

# RFID INSTALLATION

## PREPARATION FOR INSTALLATION OF RFID IN COUNTERTOP

The Inform counter offers the option to install an RFID PCB under the countertop, whether straight, curved or height adjustable. The 40 mm thick countertop is recessed below the central section to allow for the optimal positioning of the RFID PCB as needed. As far as the dimension of the countertop is concerned, the central recessed section leaves a peripheral circumference of 80 mm to 110 mm to preserve the visual aesthetics of the 40 mm top. In the recessed section, the countertop is 20 mm thick, thus complying with the technical specifications of most RFID systems for counters.

---

### RFID installation in 45° curved counters

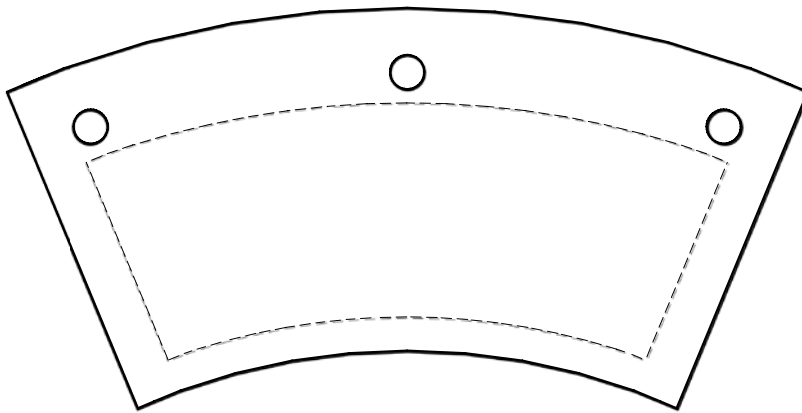

### RFID installation in 90° curved counters

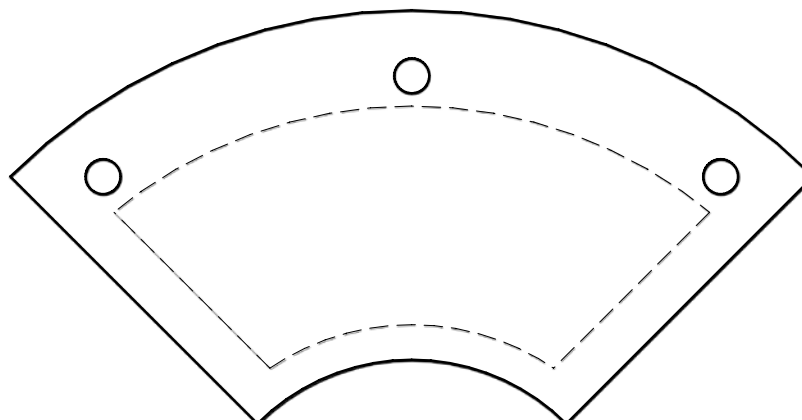

# LOCATIONS

WE ARE LIBRARY PEOPLE®



## DENMARK

Lammhults Biblioteksdesign A/S  
Dalbækvej 1  
6670 Holsted

bci@bci.dk  
www.bci.dk

## FRANCE

BC Intérieur Sarl  
6 allée Kepler  
77420 Champs sur Marne

bci@bcinterieur.com  
www.bcinterieur.com

## BELGIUM

SBNL - Schulz Benelux BVBA  
Appelweg 94 C  
3221 Holsbeek

info@sbnl.be  
www.sbnl.be

## SWEDEN

Lammhults Biblioteksdesign AB  
Odlarevägen 16  
226 60 Lund

eurobib@eurobib.se  
www.eurobib.se

## GERMANY

Schulz Speyer Bibliothekstechnik AG  
Hafenstraße 2  
67346 Speyer

sales@schulzspeyer.de  
www.schulzspeyer.de

## UNITED KINGDOM

thedesignconcept Ltd.  
The Old Bakery,  
10 Greenless Road  
Cambuslang Belgrave Street  
Glasgow G72 8JJ

info@thedesignconcept.co.uk  
www.thedesignconcept.co.uk

## NORWAY

BS Eurobib AS  
Alf Bjerckes Vei 20  
0582 Oslo

post@bseurobib.no  
www.bseurobib.no